



# USER MANUAL

## RM1350

### REFRIGERATOR FOR LP-GAS & ELECTRIC OPERATION

#### FOR YOUR SAFETY

If you smell gas:

1. Open windows.
2. Don't touch electrical switches.
3. Extinguish any open flame.
4. Immediately call your gas supplier.

#### POUR VOTRE SÉCURITÉ

Si vous sentez une odeur de gaz:

1. Ouvrez les fenêtres.
2. Ne touchez à aucun interrupteur.
3. Éteignez toute flamme nue.
4. Avertissez immédiatement votre fournisseur de gaz.

#### FOR YOUR SAFETY

Do not store or use gasoline or other flammable vapors and liquids in the vicinity of this or any other appliance.

#### POUR VOTRE SÉCURITÉ

Ne pas entreposer ni utiliser de l'essence ni d'autres vapeurs ou liquides inflammables à proximité de cet appareil ou de tout autre appareil.

#### **WARNING**

Improper installation, adjustment, alteration, service or maintenance can cause injury or property damage. Refer to this manual. For assistance or additional information consult a qualified installer, service agency or the gas supplier.

#### **AVERTISSEMENT**

Une installation, un réglage, une modification, une réparation ou un entretien non conforme aux normes peut entraîner des blessures ou des dommages matériels. Lisez attentivement le mode d'emploi fourni avec l'appareil. Pour obtenir de l'aide ou des renseignements supplémentaires, consultez un installateur ou un service d'entretien qualifié ou le fournisseur de gaz.



#### USA

Service Office  
Dometic Corporation  
2320 Industrial Pkwy.  
Elkhart, IN 46516  
Phone: 574-294-2511

#### Corporate Office

2320 Industrial Parkway Elkhart, IN 46516

#### For Service Center Assistance

Call: 800-544-4881

#### CANADA

Dometic Corporation  
46 Zatonski, Unit 3  
Brantford, ON N3T 5L8  
CANADA  
Phone: 519-720-9578

# INTRODUCTION

Thank you for entrusting us to supply your new quality-guaranteed refrigerator. The refrigerator model RM1350 is to be used as a recreational device designed for storage of foods, frozen foods and making ice. Please, when the refrigerator is not in use as a recreational device, turn the system off and open the door(s).

This manual should be kept and stay with the refrigerator if it is ever moved or change owners. Read it carefully to ensure that you know how to operate the refrigerator safely and correctly. Be aware of possible safety hazards when seeing alert symbols on the refrigerator as well as in this manual.

Note that installation and servicing should be performed by qualified personnel only! Thus, the section regarding maintenance and service is intended for service personnel. For installation instructions, refer to the INSTALLATION MANUAL.

## CONTENTS

REFRIGERATOR OVERVIEW .....	3	TROUBLESHOOTING .....	16
OPERATING INSTRUCTIONS .....	8	DIAGNOSTIC TEST .....	17
STORAGE COMPARTMENTS .....	10	APPENDIX A - SPARE PARTS .....	18
PRODUCT CARE .....	12	APPENDIX B - CONSUMER SUPPORT .....	19
MAINTENANCE & SERVICE .....	12	APPENDIX C - DOMETIC WARRANTY & MAINTENANCE SCHEDULE .....	20

## MODEL DENOMINATIONS

The following model denominations are used:

RM1350	Automatic door lock and door insert panels or steel doors.
RM1350M	Manual door lock and door insert panels or steel doors.
RM1350IM	Automatic door lock, ice maker and door insert panels or steel doors.
RM1350MIM	Manual door lock, ice maker and door insert panels or steel doors.
RM1350WIM	Automatic door lock, ice maker, water dispenser and door insert panels or steel doors.

## SYMBOLS

The following symbols are used throughout the manual:



Indicates a potentially hazardous situation, which, if not avoided, could result in death or serious injury.



Indicates a potentially hazardous situation, which, if not avoided, may result in minor or moderate injury.



Used without the safety alert symbol indicates, a potentially hazardous situation which, if not avoided may result in property damage.



Information



Step-by-step instructions

# REFRIGERATOR OVERVIEW

## MODELS WITH THE AUTOMATIC DOOR LOCKING SYSTEM

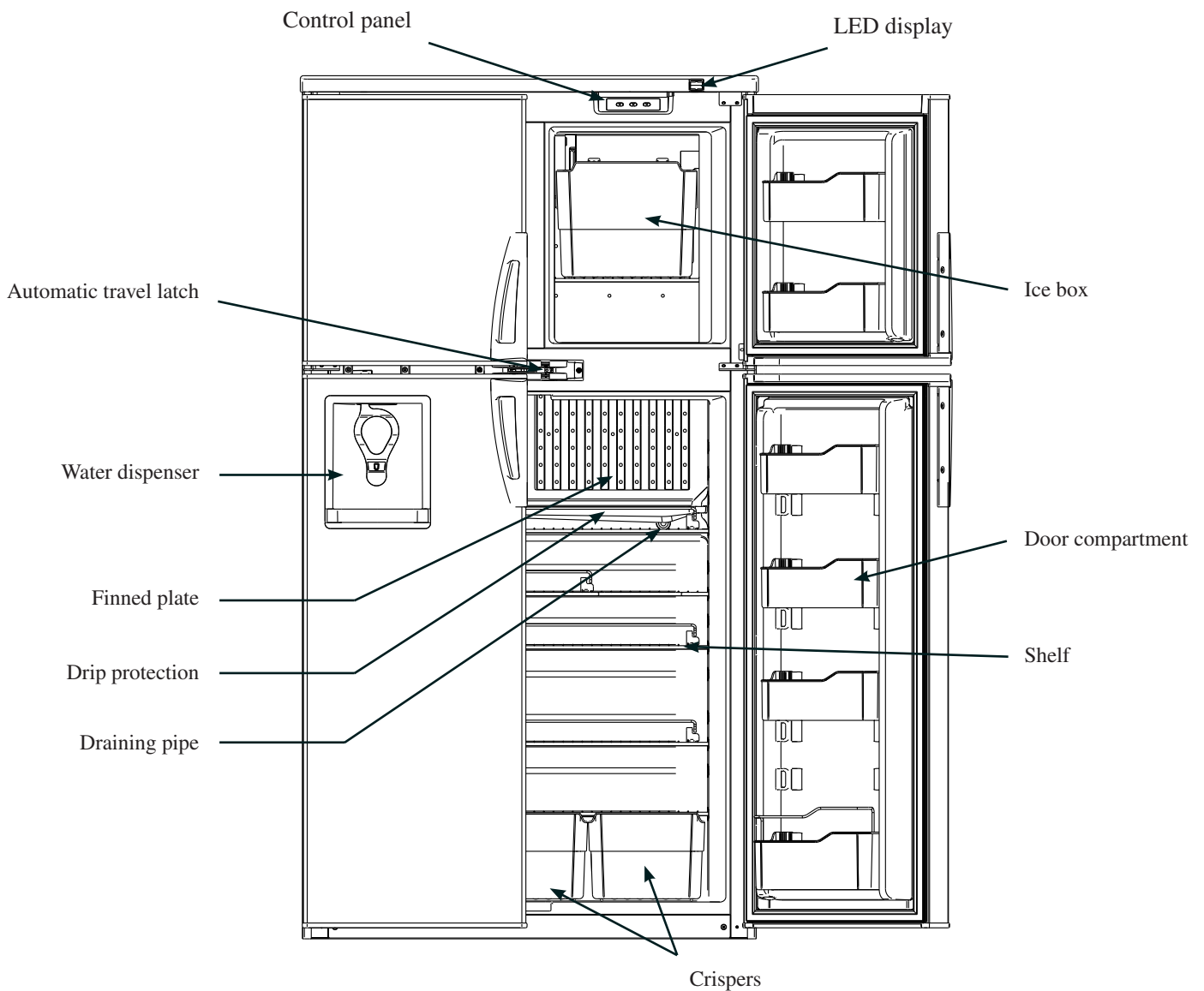

*Models: RM1350, RM1350IM and RM1350WIM. General view of the appliance. Model shown is equipped with ice maker and water dispenser. The number of shelves and door compartments may vary according to the user's requirements.*

# REFRIGERATOR OVERVIEW

## MODELS WITH THE MANUAL DOOR LOCKING SYSTEM

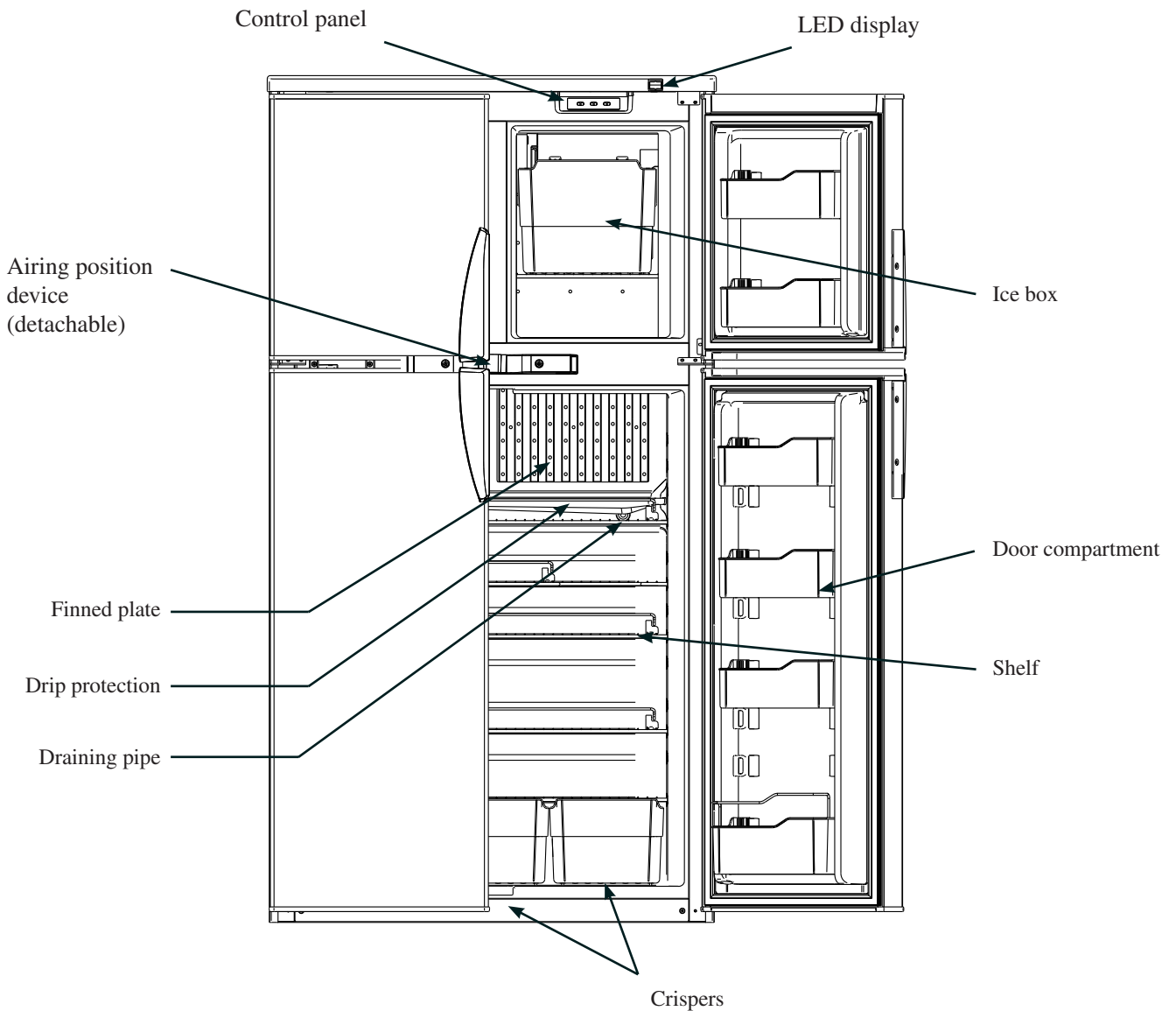

*Models: RM1350M and RM1350MIM. General view of the appliance. Model shown is equipped with ice maker. The number of shelves and door compartments may vary according to the user's requirements.*

# REFRIGERATOR OVERVIEW



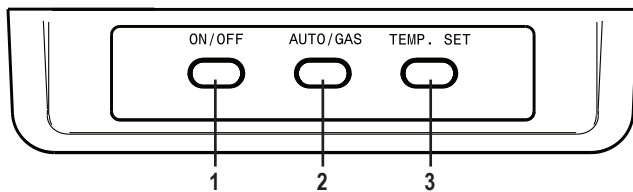





## CONTROL PANEL



1. **ON/OFF button (main power)**  
Press the button to turn the refrigerator ON or OFF.
2. **AUTO/GAS mode selector button**  
Press the button to turn the AUTO mode ON or OFF.
3. **TEMP. SET button**  
The thermostat has 5 settings where 1 indicates the warmest and 5 the coldest temperature setting. Press the button repeatedly until the desired setting, e.g. 3, is shown in the LED display. This value is shown for about 5 seconds and then the temperature is displayed again.

## LED DISPLAY PANEL

The LED display panel provides a quick visual indicator of the temperature of the food in the fresh food cabinet, status messages, and alarm conditions. For RM1350, RM1350M, RM1350IM, RM1350MIM and RM1350WIM, the AUTO and LP mode indication lamps show the mode of operation.

LED PANEL INDICATIONS	STATUS INFORMATION
	Fresh food temperature.
	Thermostat range setting indication (1 - 5). Temporary during setting. The thermostat settings are stored automatically after 5 sec. of inactivity.
	"60" is displayed. Indicates that the temperature is above measurement range.
	AUTO mode lamp is lit. Indicates AUTO mode and AC operation
	AUTO and LP mode lamps are lit. Indicates AUTO mode and GAS operation.
	LP mode lamp is lit. Indicates manual gas operation mode.
	"LP" flashing (message alternates between "LP" and the temperature). Indicates gas operation lock out. Check gas.
	AUTO mode lamp is lit and LP mode lamp is flashing. Indicates temporary gas operation lockout.

# REFRIGERATOR OVERVIEW

## MODELS WITH THE AUTOMATIC DOOR LOCKING SYSTEM

### AUTOMATIC TRAVEL LATCH

The refrigerator is equipped with a travel latch that automatically locks the refrigerator's doors when the RV's engine is running. When the RV's engine is turned off, the latch unlocks the doors.



To open one of the refrigerator doors while the engine is running, the travel latch must be manually unlocked. To unlock, simply slide the shutter to the left. The doors will automatically lock again after 5 seconds.

### IF THE REFRIGERATOR HAS BEEN TURNED OFF

When the engine is turned on, a signal through the alternator (D+) activates the travel latch which in turn locks the refrigerator doors. When turning off the engine, the doors will *not* open automatically as usual because the refrigerator is turned off. In order to switch on the refrigerator, the doors must be manually unlocked.

### AIRING POSITION

When the refrigerator is turned off for a period of time it is recommended that the refrigerator is emptied, defrosted, cleaned and that the doors are left ajar. To ensure the doors stay ajar, use the automatic travel latch's airing position functionality.

1. Open the refrigerator doors. Slide the shutter to the right. The automatic travel latch is locked.

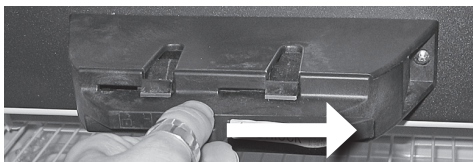

2. Gently close the doors (a) until the pins click into position (b).

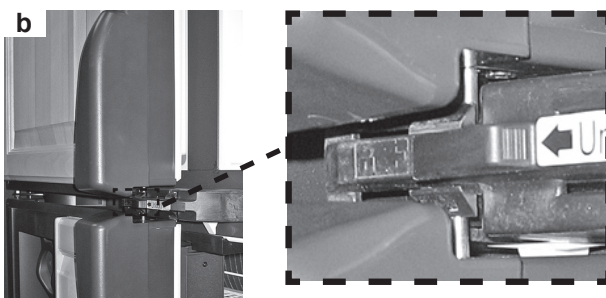
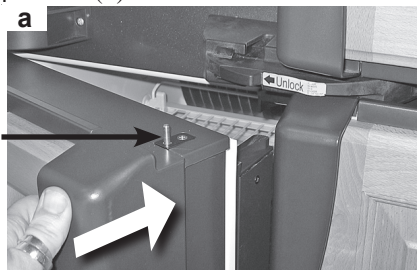

3. Verify that a small spacing has been created between the cabinet and the doors and that the doors have not been closed completely. If so, unlock the latch and close the doors again.
4. In order to open the doors again the travel latch must be unlocked. Push to close the doors completely and then, slide the shutter to the left to unlock the latch.



## MODELS WITH THE MANUAL DOOR LOCKING SYSTEM

### MANUAL LOCKING SYSTEM

The refrigerator is equipped with a manual locking system. The doors are automatically locked when closed. To unlock, simply open the doors as usual.

### AIRING POSITION

When the refrigerator is turned off for a period of time it is recommended that the refrigerator is emptied, defrosted, cleaned and that the doors are left ajar. Use the detachable airing position device to ensure the doors stay ajar.



1. Open the doors and slide the device in place.

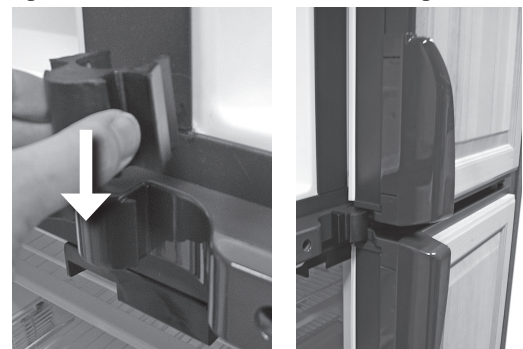

2. Close the refrigerator doors. These will immediately hook to the front edge of the airing position device creating a small spacing between the cabinet and the doors.

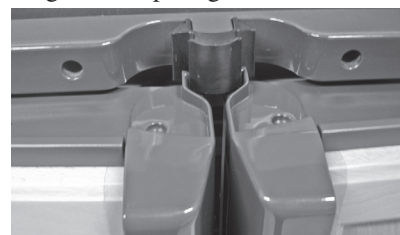

3. To detach, open the doors and slide the device upward. Remove and keep in a safe place. Close the doors.



# REFRIGERATOR OVERVIEW

## ABSORPTION COOLING SYSTEM

In an absorption refrigerator system, ammonia is liquefied in the finned condenser coil at the top rear of the refrigerator. The liquid ammonia then flows into the evaporator (inside the freezer section) and is exposed to a circulating flow of hydrogen gas, which causes the ammonia to evaporate, creating a cold condition in the freezer.



**When starting this refrigerator for the very first time, the cooling cycle may require up to four hours of running time before the cooling unit is fully operational.**

The tubing in the evaporator section is specifically sloped to provide a continuous movement of liquid ammonia, flowing downward by gravity through this section.

Sodium chromate is used for corrosion protection (less than 2 weight % of the coolant).

## LEVELING THE REFRIGERATOR

Leveling is one of the requirements for proper operation with absorption refrigerators. To ensure proper leveling the vehicle needs to be leveled only so it is comfortable to live in (no noticeable sloping of floor or walls).

Any time the vehicle is parked for several hours with the refrigerator operating, the vehicle should be leveled to prevent this loss of cooling.

If the refrigerator is operated when it is not level and the vehicle is not moving, liquid ammonia will accumulate in sections of the evaporator tubing. This will slow the circulation of hydrogen and ammonia gas, or in severe cases, completely block it, resulting in a loss of cooling.

When the vehicle is moving, the leveling is not critical, as the rolling and pitching movement of the vehicle will pass to either side of level, keeping the liquid ammonia from accumulating in the evaporator tubing.

## PURGING AIR FROM THE LINES

If the refrigerator has not been used for a long time - or - the LP tanks have just been refilled, air may be trapped in the supply lines. To purge the air from the lines, turn the refrigerator off and on by pressing the ON/OFF button. If the flame is not lit within 45 seconds, turn the refrigerator off and back on again. This procedure can be repeated 3 to 4 times. If repeated attempts fail to start the LP gas operation, check to make sure that the LP gas supply tanks are not empty and that all manual shutoff valves in the lines are open.

## AUTOMATIC COOLING UNIT CYCLING SYSTEM AND LOW AMBIENT CONTROL

The refrigerator has been design with an automatic cooling unit cycling system that helps reduce frost build up in the fresh food compartment. The first automatic frost reduction cooling unit cycle begins 60 hours after turning "on" the refrigerator (for best operational results the refrigerator should be turned on anytime between 4 and 10 PM), and will last for approximately 120 minutes. Thereafter, the cycle will automatically repeat every 48 hours as long as the refrigerator continues to run.

The automatic Low Ambient Control (LAC) ensures trouble-free operation in low ambient temperatures (e.g below 50° F).

## AUTO MODE / GAS MODE

The refrigerator is equipped with a control system where the user can choose to turn the AUTO mode on or off.

### AUTO MODE IS TURNED ON

The system is fully automatic which means that it selects the most suitable energy source available, either 120 V AC or LP gas operation.

#### Temporary gas lockout:

The gas operation will automatically be locked out for a period of 15 minutes when the engine is switched off. This will prevent gas operation e.g. when stopping at a refueling station.

### AUTO MODE IS TURNED OFF (GAS MODE)

The system operates on LP gas only. The control system activates the ignition system and makes three attempts to light the burner for a period of approx. 45 sec. at two minute intervals.

Note that the temporary gas lockout feature does not work when the AUTO mode is turned off! Consequently, when parking close to a gasoline pump all LP gas appliances vented to the outside of the vehicle must be turned off. Otherwise gasoline fumes from gasoline pumps might enter LP gas appliance and these can then ignite from the burner flame and cause a fire or an explosion.

## WARNING

**FIRE OR EXPLOSION HAZARD. When refueling or parked near gasoline pumps, when the AUTO mode is turned off, shut off all LP gas appliances. Failure to heed this warning could cause a fire or explosion resulting in death or severe personal injury.**

# OPERATING INSTRUCTIONS

## TURNING ON THE REFRIGERATOR

### ⚠ WARNING

**FIRE HAZARD.** Before lighting the gas burner, after that the RV has not been used for some time, please check that the gas path between the burner jet and the burner tube has not been obstructed. Failure to heed this warning could cause a fire resulting in personal injury.

### GAS EQUIPMENT ASSEMBLY

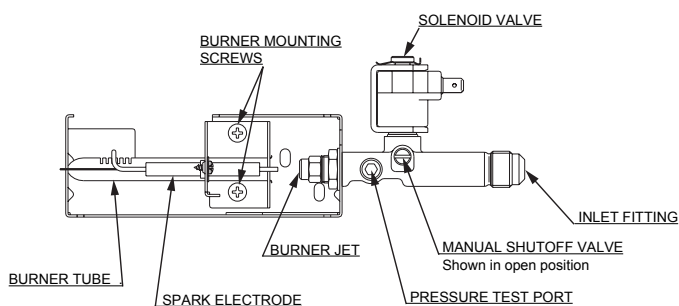

1. Check that all the manual gas valves are in the ON position.
2. Make sure that a continuous 12V DC supply is available for the electronic control to function.
3. Press the ON/OFF button.
4. Select operation mode:
  - AUTO mode (AC and GAS)  
Press the AUTO/GAS mode selector button (if not already on).
  - GAS mode (gas operation only)  
Press the AUTO/GAS mode selector button to turn off the AUTO mode (if not already off).

## ADJUSTING THE THERMOSTAT

The adjustable thermostat ranges from 1 - 5 (5 = coldest temperature setting).

1. After the initial start-up, adjust the thermostat by pressing the TEMP. SET button repeatedly until the desired setting is displayed.

The thermostat controls both the gas and electric operation. Thus, it is not necessary to reset each time a different energy source is employed.

## ICE MAKER

### ▲ RM1350IM, RM1350MIM & RM1350WIM

Before the ice maker can operate, make sure that:

- The refrigerator is connected to 120 V AC .
- The water valve supplying the refrigerator is turned on.
- The ice level bail arm is in its fully down position.

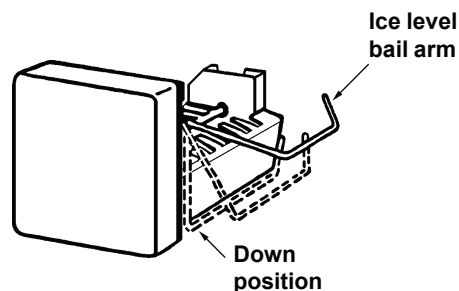

When the ice maker thermostat senses the preset temperature for the ejection of the ice cubes, the fingers will start to rotate, dumping any ice cubes and filling the mold with water. When the storage container is full, the bail arm will come in contact with the ice cubes. The bail arm cannot return to the full down position and the ice production is stopped until the bin is emptied, or ice cubes are removed.

To prevent water from splashing out of the mold assembly when your recreational vehicle is moving, raise the bail arm to the full "UP/OFF" position about 1-1/2 hours before departing. This will allow the water in the mold to freeze.

## WATER SUPPLY

The water supply system must have a minimum pressure of 15 pounds per square inch gauge (psig). A 1/4" diameter water line to the water valve should be used at the rear of the refrigerator. The water line must have a manual shutoff valve placed where it is easily accessible.

The maximum water level is represented by a thin line. It is essential that the water level does not exceed this line!

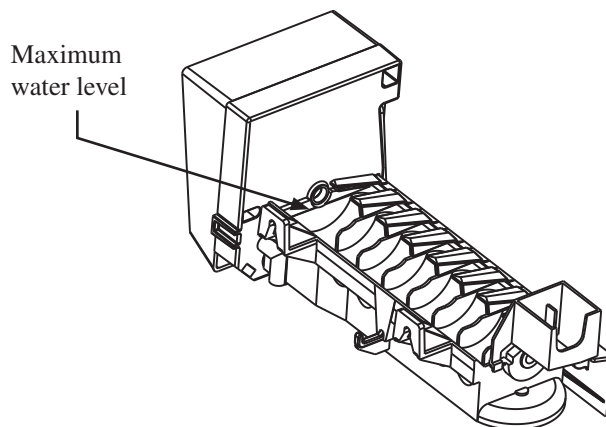

If necessary change the water flow by adjusting the water supply, see the step-by-step instruction in the following section ADJUSTING THE SIZE OF CUBES.



# OPERATING INSTRUCTIONS

## ADJUSTING THE SIZE OF CUBES



If the ice maker was cleaned and drained, no ice cubes will be dumped into the bin during the first cycle.

The first few cycles may have small cubes due to air trapped in the water lines. The first container of ice cubes should be dumped if the water system has been winterized or not used for several weeks. Once the ice maker has run through several cycles and if cubes are too small or sticking together, adjustment is necessary on the amount of water entering the mold.

TO ADJUST THE SIZE OF CUBES, FOLLOW THESE STEPS:



1. Remove the protective cover from the ice maker mechanism.
2. Locate the adjusting screw under the protective cover. Turn the screw counterclockwise to increase the size of cubes.

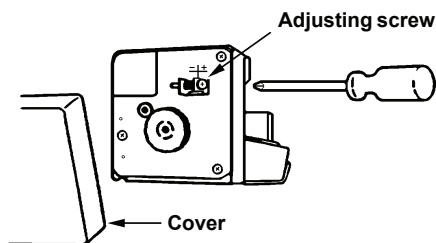

3. Turn the screw clockwise to decrease the cube size or if the mold is overflowing, and the cubes are stuck together.



To prevent overflowing, do not turn the adjustment screw more than one revolution at a time. Allow the ice maker to cycle several times before another adjustment is made. Be sure to replace the protective cover on the cycle after the adjustments are complete.

## WATER DISPENSER

### ▲RM1350WIM

TO DISPENSE WATER, FOLLOW THESE STEPS:



1. Verify that the water valve supplying the refrigerator is turned on.
2. Insert a glass in the dispensing cavity and simply press the lever. This will activate a switch which turns on an electric water valve at the back of the refrigerator. Water will flow through a separate tube and out of the dispenser.

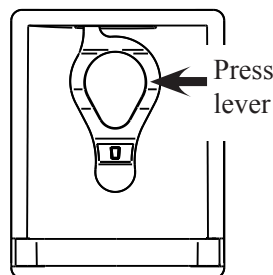

3. To stop dispensing, pull glass away from dispensing arm before the glass is full.



If new installation, or used infrequently, dispense numerous glasses of water before use. To keep the water fresh, it is recommended to use the dispenser every day.

## TURNING OFF THE REFRIGERATOR

The refrigerator may be shut off while in any mode of operation by pressing the ON/OFF button. This shuts off all DC power to the refrigerator, including the interior light.

If the refrigerator will not be in operation for a period of weeks, it should be emptied, defrosted, cleaned and the doors left ajar. The ice trays should also be dried and kept outside the cabinet.

# STORAGE COMPARTMENTS

## ⚠ WARNING

**EXPLOSION HAZARD.** Never store explosive substances in the refrigerator, such as cigarette lighter fuel, gasoline, ether or the like. Failure to heed this warning could cause an explosion resulting in death or severe personal injury.

## REFRIGERATOR VOLUME

Total refrigerator volume: 12.3 cu.ft

## FOOD STORAGE COMPARTMENT

- Cool the refrigerator before placing any food inside.
- The food storage compartment is completely closed and unventilated, which is necessary to maintain the required low temperature for food storage. Consequently, foods having a strong odor or those that absorb odors easily should be covered.
- Vegetables, salads etc. should be covered to retain their crispness.
- The coldest positions in the refrigerator are under the cooling fins and at the bottom of the refrigerator. The warmer areas are on the upper door shelves. This should be considered when placing different types of food in the refrigerator.
- Arrange all food in the unit to allow for free air circulation. Do not overpack because a stuffed refrigerator must work harder and will have higher cabinet temperatures.
- Never put hot food or drinks into the refrigerator - cool them first.
- Do not leave the unit's door open any longer than necessary. This will reduce frost formation and increase the efficiency of the refrigerator.

## FROZEN FOOD STORAGE COMPARTMENT

This compartment is not designed for deep or quick freezing of food. To prevent food from drying out, keep it in covered dishes, containers, plastic bags or wrapped in aluminum foil.

- Quick frozen soft fruits and ice cream should be placed in the coldest part of the compartment, which is at the bottom of the aluminum liner.
- Frozen vegetables, may be stored in any part of the compartment.
- Meat or fish, whether raw or prepared, can be stored in the frozen food storage compartment provided they are pre-cooled first in the refrigerator. They can be stored about three times longer in the frozen food compartment as compared to the fresh food compartment.
- To prevent frost buildup, which can reduce the efficiency, wipe excess moisture off items being placed in the compartment.

## SHELVES

### SHELF GUARDS

To prevent food product containers from shifting, two slidable retainer bars are mounted on the shelves. These can be employed to separate the shelf into smaller sections which will hold the contents in place. Slide the shelf guards snugly against food item(s). The "front to back" shelf guard must be in upright position.

GUARDS IN UPRIGHT POSITION



### REMOVING AND REPLACING THE SHELVES

It is possible to arrange the shelves in many ways to fit your needs. To gain more space, a shelf can be removed and locked into an upright position at the rear of the refrigerator compartment.

Remove the shelf locks as described on the following page, tilt the shelf (A) and secure with the shelf locks (B).

A

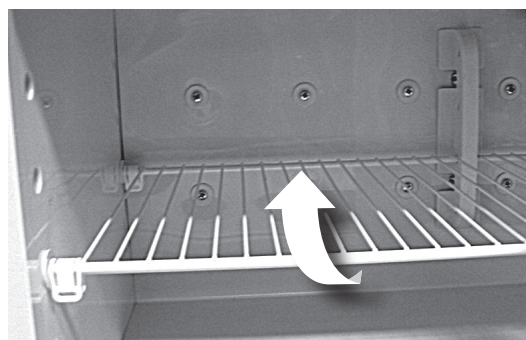

B

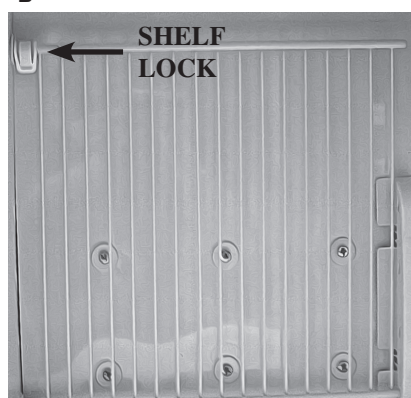

# STORAGE COMPARTMENTS

A general description of how to remove and replace the shelves. The number of shelves and positions may vary between refrigerator models.

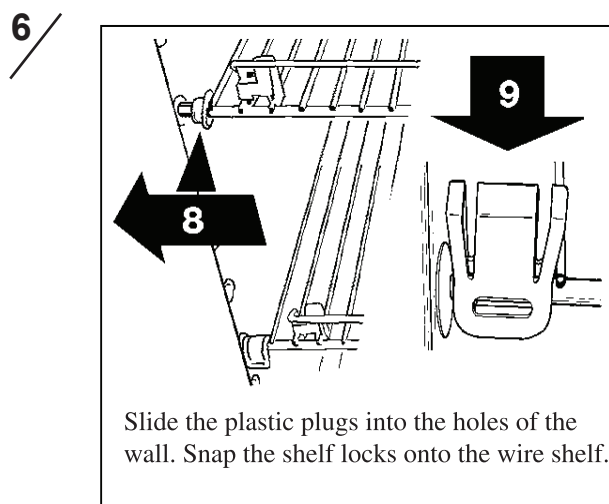
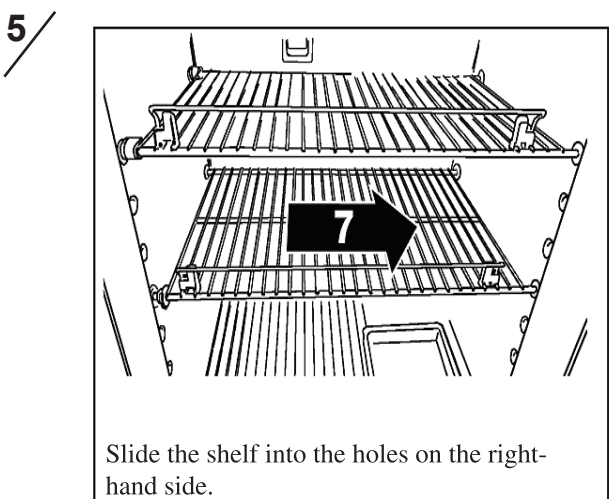
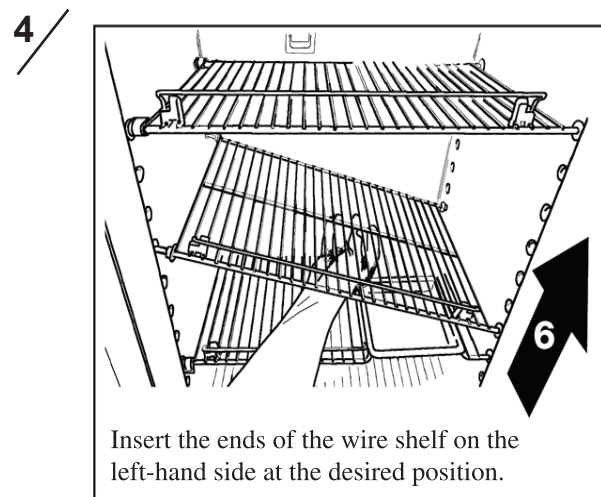
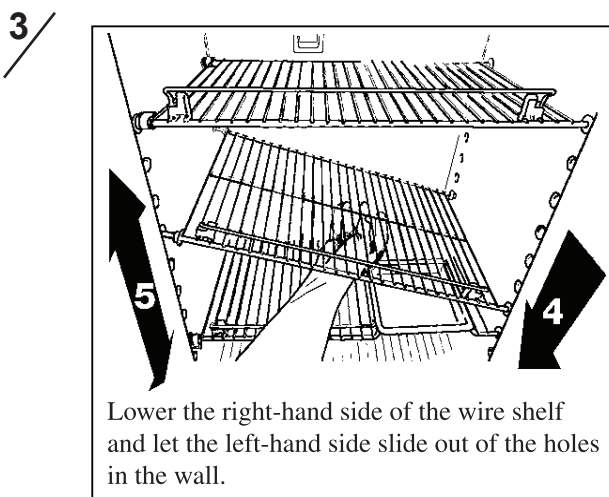
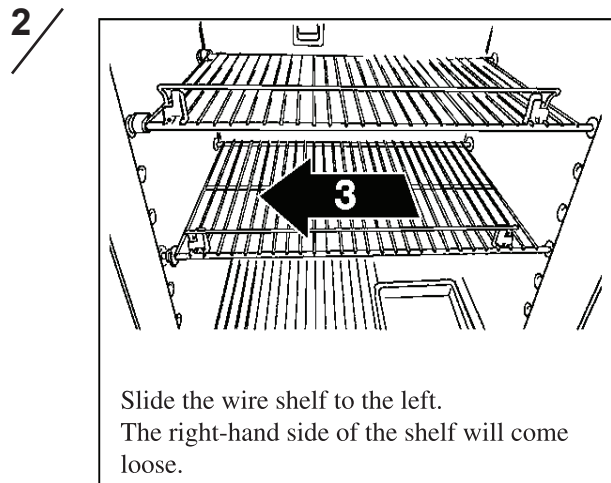
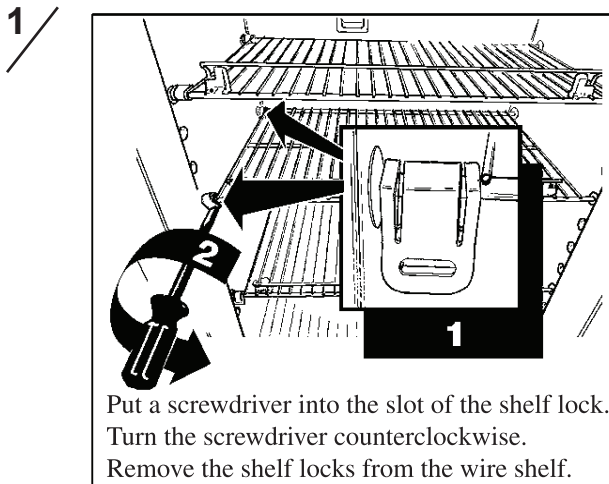

## PRODUCT CARE

### CLEANING

Always keep the refrigerator clean. Cleaning the refrigerator is usually done after it is defrosted or put into storage. Use lukewarm weak soda solution to clean the interior liner of the refrigerator. Use warm water only to clean the finned evaporator, gasket, ice tray and shelves.

#### CAUTION

**Never use strong chemicals or abrasives to clean these parts, as the protective surfaces will be damaged. Do not spray liquids near electrical outlets, connections or the refrigerator components.**

To keep the refrigerator operating efficiently and safely, periodic inspection and cleaning of several components once or twice a year is recommended:

- Check the lower vent, upper vent and area between these openings for any obstructions such as bird/insect nests, spider webs, etc.
- Make sure the refrigerator area is free from combustible material, gasoline and other flammable vapors or liquids.
- Clean the coils on the back of the refrigerator. Use a soft bristled brush to dust off the coils.

In order to keep the refrigerator working properly it is important that service is performed on a regular schedule. At least once a year, a qualified service technician should inspect the connections, the control system, the LP gas pressure and flue baffle.

### DEFROSTING



1. Shut off the refrigerator by pressing the main power ON/OFF button (OFF position).
2. Empty the refrigerator.
3. Leave the cabinet and freezer doors open and place the drip tray under the finned evaporator. Defrosting time can be reduced by filling the ice trays with hot water and placing them in the freezer compartment.

#### CAUTION

**Do not use:**

- **A knife or an ice pick, or other sharp tools to remove frost from the freezer shelves.**
- **A hot air blower. Permanent damage could result from warping the metal or plastic parts.**

4. When all the frost has melted, dry the interior with a clean cloth.
5. Replace the food and set the thermostat to the coldest setting for a few hours. Then, reset the thermostat to the desired setting, usually at mid setting.

## MAINTENANCE & SERVICE

#### CAUTION

**If your refrigerator stops cooling, immediately turn the refrigerator off and see a Dometic dealer.**

### STORAGE PROCEDURE / WINTERIZING THE REFRIGERATOR

#### ▲RM1350IM, RM1350MIM & RM1350WIM

The refrigerator is equipped with a heater tape wrapped around the water solenoid valve and outlet water tube. During cold weather operation below 32°F/0°C the automatic temperature switch will turn the heater tape on automatically.

If the RV is in storage and the refrigerator or the DC power is turned OFF there will be no 12V DC present to operate the heat tape; therefore, it will be necessary to drain and dry the ice maker and the water dispenser (if applicable). This will prevent water from freezing in the solenoid valve or becoming stale and producing bad tasting ice.

If the temperatures are expected to reach or exceed 0°F/-18°C the ice maker and water dispenser (if applicable) must be drained to prevent component damage and leaks. For instructions, see the following sections DRAINING THE ICE MAKER and DRAINING THE WATER DISPENSER.

# MAINTENANCE & SERVICE

## DRAINING THE ICE MAKER

Draining of the ice maker must be performed by qualified service personnel only. Water, compressed air and AC power are required.

** Before starting the draining procedure, make sure the RV is level!**

TO DRAIN THE ICE MAKER, FOLLOW THESE STEPS:

-  1. Shut off water supply valve
2. Place a shallow pan under water solenoid valve.
3. Remove inlet fitting to ice maker water solenoid valve.

### WATER SOLENOID VALVE - RM1350IM

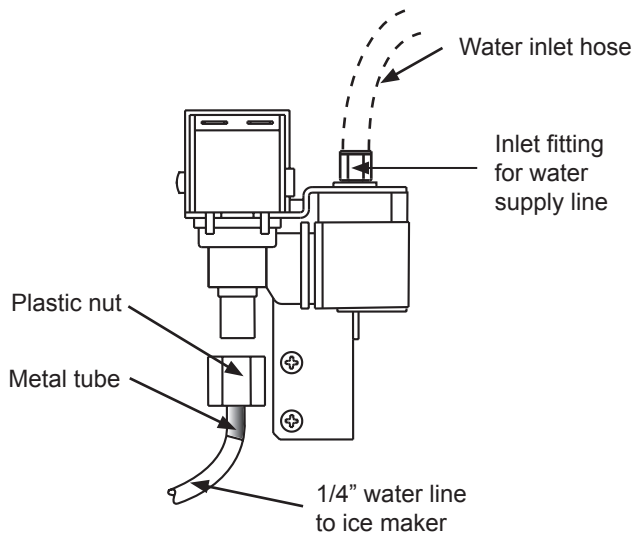

### WATER SOLENOID VALVE - RM1350WIM

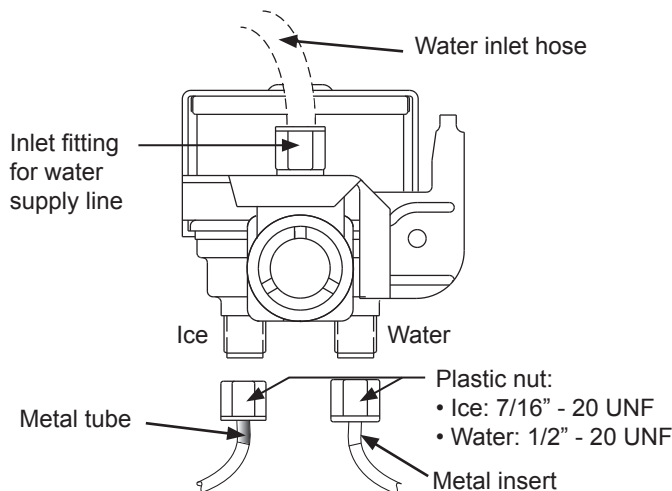

Outlet connection tubing:  
 • Ice: 1/4" plastic hose  
 • Water: 5/16" plastic hose

4. Drain water from the supply line.
5. Remove the plastic nut and water line from outlet side of the water solenoid valve.
6. Drain water from the line.
7. Connect compressed air onto the inlet fitting of the water solenoid valve.
8. Apply AC power to the solenoid valve by forcing the ice maker mold assembly through several harvest cycles.
9. Remove the plastic cover from the mold assembly. The bail arm must be in the down ("ON") position.
10. Start the harvest cycle with a flat blade screw driver inserted into the center of the small gear.

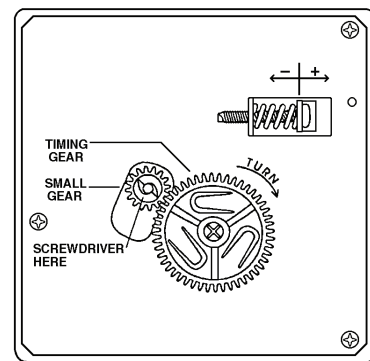

11. Turn the gear counter clockwise, when the hold switch closes, the mold assembly will continue to operate through the harvest cycle. During the water fill sequence of the harvest cycle the compressed air will blow out the water trapped in the solenoid valve.
12. Repeat the harvest cycle operation several times. Up to 20 PSIG air pressure can be used to clear the solenoid valve. Damage to solenoid can occur if AC power is applied for more than 20 seconds.
13. Make sure that the metal tube is in the plastic water line to the ice maker.
14. Reconnect and tighten lines on water solenoid valve. Leave the water supply turned off until temperatures are above 0°F/-18°C
15. Dry the ice maker mold assembly with a soft cloth.
16. Place bail arm in the "UP/OFF" position.



# MAINTENANCE & SERVICE

## DRAINING THE WATER DISPENSER

### ▲RM1350WIM

If there is any possibility that the temperature can drop below freezing where the refrigerator is located, the water supply system (including the water tank and the water valve) must be drained by a qualified servicer.

TO DRAIN THE WATER DISPENSER, FOLLOW THESE STEPS:

1. Open the door. Remove the upper shelf and the drip tray.
2. Place the ice bucket on the shelf.

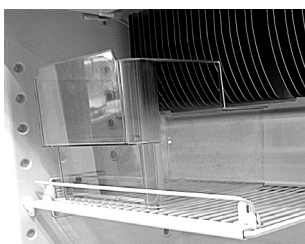

3. Unscrew the nut by hand.



4. Direct the hose into the ice bucket. Allow the water from the tank to drain.
5. To drain the tank completely, gently apply compressed air as shown in the picture below.



6. To finish off, place a dishcloth beneath the water solenoid valve. Unscrew the innermost nut (water tank). Place the hose on the dishcloth and let the water drain.



7. Reconnect and tighten the line.

## ELECTRIC EQUIPMENT

### REPLACING THE HEATER

The heat necessary for the operation of an absorption cooling unit is supplied by an electric heater mounted in a pocket of the boiler system. The refrigerator is equipped with a series connected twin heater.

TO REPLACE THE HEATERS, FOLLOW THESE STEPS:

1. Turn off the refrigerator. Unplug the power cord and disconnect the 12V DC power.
2. Remove the power module cover.
3. Disconnect the heater leads.
4. With a pair of pliers, unfold the lug holding the lid of the boiler casing and then, open the lid.
5. Remove some insulation wool for the heater to be accessible.
6. Turn and lift the heaters out of the pocket.
7. Fit the new heaters into the pocket.
8. Connect the leads and refit the power module cover.
9. Put back the insulation wool.
10. Close the lid of the boiler.

### REPLACING THE FUSES

The refrigerator is equipped with the following 3 fuses:

- 3 A fuse for the refrigerator control system.
- 5 A fuse for the AC heaters.
- 3 A in-line fuse for the fan and heat tape. For RM1350IM, RM1350MIM & RM1350WIM : For the ice maker and water dispenser.

TO REPLACE THE FUSES, FOLLOW THESE STEPS:

1. Turn off the refrigerator.
2. Unplug the power cord and disconnect the 12V wires.
3. Remove the power module cover.
4. Snap the fuse out of the fuse holder.
5. Fit the new fuse in to the fuse holder.
6. Put back the power module cover.

## PERIODIC MAINTENANCE

### CHECKING THE CONNECTIONS

LP gas is a flammable gas which has the potential to create a hazard. Do not smoke or create sparks when working on or near the LP gas system.

#### ⚠ WARNING

**EXPLOSION HAZARD.** Never use an open flame to check for gas leaks. Failure to heed this warning could cause an explosion resulting in death or severe personal injury.



# MAINTENANCE & SERVICE

TO CHECK THE CONNECTIONS FOR LEAKS, FOLLOW THESE STEPS:

1. Verify that the LP gas supply is turned on.
2. Apply a commercial non-corrosive bubble solution to all LP gas connections.
3. The appearance of bubbles indicates a leak. Shut off the main gas supply and service immediately.

## CHECKING THE CONTROL SYSTEM

Check the control system by connecting/disconnecting the 120V AC power, starting/stopping the engine, etc.

## CHECKING THE LP GAS PRESSURE

The LP gas pressure should be checked and the main regulator readjusted if the pressure is incorrect. The correct operating pressure is 11 inches of water column. Measure the LP gas pressure at the test port, just ahead of the burner jet.

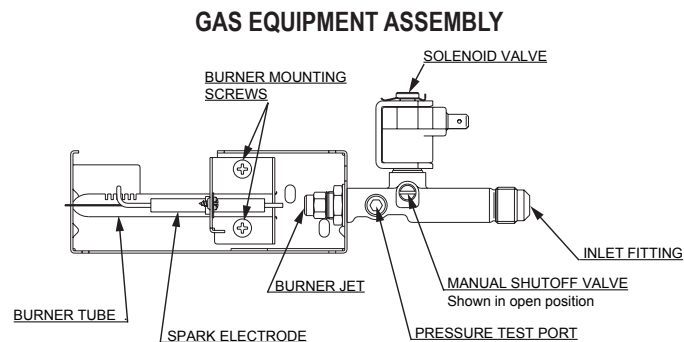

## CLEANING THE FLUE BAFFLE AND BURNER

Inspect the flue baffle. It should be reasonably clean and free of soot. Heavy soot formation indicates improper functioning of the burner.

TO CLEAN THE FLUE AND BURNER, FOLLOW THESE STEPS:

1. Turn off the refrigerator.
2. Unplug the power cord from the 120V AC outlet. Disconnect the wires or shut off the 12V DC power supply to the refrigerator.
3. Turn off the manual shut off valve.
4. Remove cover from burner housing. Remove the burner mounting screws and then, the burner assembly.
4. Remove the wire and flue baffle from the top of the flue tube.
5. Using a flue brush, clean the flue from the top. Blowing compressed air into the flue will *not* properly clean soot and scale out of the flue tube.
6. Put back the flue baffle.
5. Clean the burner tube with a brush. Blow out the burner with compressed air.

6. Remove burner jet, but first, clean burner area of soot and scale that fell out of flue tube.
7. Remove the burner jet.
8. Soak the jet in wood alcohol and blow it out with compressed air.

## ⚠ WARNING

**FIRE HAZARD. Do not use a wire or pin when cleaning the burner jet as damage can occur to the precision opening. Failure to heed this warning could cause fire resulting in personal injury.**

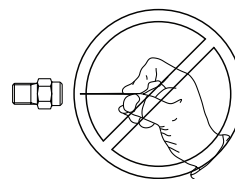

9. Reinstall and tighten the burner jet.
10. Reinstall the burner. Ensure the end of the burner fits into the slot on the burner bracket. Verify that the slots are centered under the flue tube and the thermocouple is positioned properly (tip of thermocouple extends over two slots of burner).

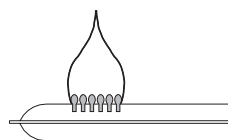

*Be sure to check the burner flame for proper appearance. The flame should be light blue. If it has a yellow tip, it means that it is burning incorrectly.*

11. Check the electrode for proper location and gap.

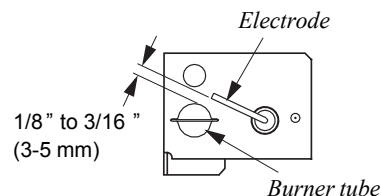

12. Turn on the manual gas shut off valve.
13. Examine all fittings for leaks. (Use a commercial non-corrosive bubble solution.)
14. Connect the 120V power cord. Reconnect/turn on the 12V DC power.
15. Check the LP gas safety shut off.

# TROUBLESHOOTING

If you run into a problem, refer to the troubleshooting table below.

SYMPTOM	CHECK/REMEDIAL ACTION
The refrigerator has stopped cooling.	<ul style="list-style-type: none"> <li>• Immediately turn the refrigerator off and see a Dometic dealer.</li> </ul>
Refrigerator or freezer is not cold enough	<ul style="list-style-type: none"> <li>• Check the thermostat and adjust if necessary.</li> <li>• Is there a power failure?</li> <li>• Is the refrigerator level? (Because of its operation it is important to keep an absorption refrigerator level.)</li> <li>• Has the overheating protection been triggered or not?</li> <li>• Door closing properly? Check the door gasket.</li> <li>• Heavy frost build-up on evaporator fins? To prevent frost buildup do not leave the unit's door open longer than necessary.</li> <li>• Overpacked refrigerator? The unit will have to work harder if the refrigerator is stuffed and results in higher cabinet temperatures. Arrange the food in the unit to allow for free air circulation.</li> </ul>
The refrigerator does not work on 120V AC	<ul style="list-style-type: none"> <li>• Is the plug firmly connected to the receptacle? Is the socket switched on? Check the receptacle by plugging in another appliance.</li> <li>• Are the fuses intact for the AC supply and control system?</li> </ul>
The refrigerator does not work in gas operation mode	<ul style="list-style-type: none"> <li>• Gas bottle empty? Change the gas bottle</li> <li>• Air in the gas pipe? See REFRIGERATOR OVERVIEW &gt; PURGING AIR FROM THE LINES</li> <li>• Is the burner dirty, damaged or not properly located under the flue tube?</li> <li>• Is the burner jet clogged?</li> <li>• Is the flue baffle inserted properly in the flue tube?</li> <li>• Is the LP gas pressure low at burner? Set the main regulator to regulate the pressure so it does not drop below 11 inches water column at pressure tap.</li> </ul>
Odors from fumes	<ul style="list-style-type: none"> <li>• Dislocated burner</li> <li>• Damaged burner</li> <li>• Dirty flue tube</li> </ul>

If the problem persists and the refrigerator is still not working properly, contact your nearest Service Center. State the problem, model, product- and serial-number. These details are stated on the data label inside the refrigerator compartment.

## WARNINGS

For information about warnings, refer to the following table. The messages are displayed flashing (alternating between temperature and the message).

WARNINGS	INFORMATION
<b>LP</b>	Gas ignition failed. Gas bottle empty, the manual valve(s) are closed or burner jet clogged.

# TROUBLESHOOTING

## ERROR CODES

For information about error codes, refer to the following table. The codes are displayed flashing (alternating between temperature and message).

ERROR CODE	INFORMATION
<b>E0</b>	No communication between display and power modules. The temperature setting will be maintained at the mid positions. The power module will continually attempt to reestablish operation of the display module. The control system will revert to full automatic operation selecting the best energy source available with AC, GAS priority.
<b>E1</b>	Hardware fault in the gas operation system.
<b>E2</b>	A failure of the temperature sensor device or associated electronic circuitry has occurred

## DIAGNOSTIC TEST

TO PERFORM A DIAGNOSTIC TEST, FOLLOW THESE STEPS:



1. Turn off the refrigerator.
2. Press and hold the TEMP. SET button and then, press the ON/OFF button.
3. Release the TEMP. SET button. Press it again to toggle the list of functions step by step.

For information about test functions and indications, refer to the following table. The LED panel will display a number of messages. These are displayed flashing - alternating between Test indication, e.g. "F" and Test result indication. e.g. "E2".

NO	TEST FUNCTION	TEST INDICATION	TEST RESULT INDICATION
1	All outputs off	<b>F</b>	<b>E0</b> → Communication fault <b>E2</b> → Temperature sensor fault The actual temperature at the sensor (°F).
2	Turn LAC (Low Ambient Control) heater on	<b>LH</b>	<b>E0</b> → Communication fault <b>ON</b> → LAC heater on Press the lamp switch. The lamp should still be on.
3	Turn AC heater on	<b>AC</b>	<b>E0</b> → Communication fault <b>ON</b> → AC heater on “ ” → AC heater off, AC not available
4	D+ status Alternator voltage	<b>DP</b>	<b>E0</b> → Communication fault <b>ON</b> → D+ > 2V - ≤14 V “ ” → D+ < 2V
5	Run gas (one attempt only)	<b>LP</b>	<b>E0</b> → Communication fault <b>E1</b> → Igniter and valve off, gas hardware fault <b>ON</b> → Igniter and valve on <b>FL</b> → Igniter off and valve on, flame detected “ ” → Igniter and valve off, gas problem (check gas) (If flame is not ignited within 45 seconds)

## APPENDIX A - SPARE PARTS

The following table displays commonly used parts which should be available from your Dometic Service Center.

SPARE PARTS	PART NO	MODELS
Airing position device	3851270029	RM1350M, RM1350MIM
Baffle	2932667054	RM1350, RM1350M RM1350IM, RM1350MIM RM1350WIM
Burner	955001672	RM1350, RM1350M RM1350IM, RM1350MIM RM1350WIM
Crisper	3851089015	RM1350, RM1350M RM1350IM, RM1350MIM RM1350WIM
Door shelf	3850973011	RM1350, RM1350M RM1350IM, RM1350MIM RM1350WIM
Door shelf, lower	3851052013	RM1350, RM1350M RM1350IM, RM1350MIM RM1350WIM
Electrode	2932781046	RM1350, RM1350M RM1350IM, RM1350MIM RM1350WIM
Heater (420W, 120V)	3850644539	RM1350, RM1350M RM1350IM, RM1350MIM RM1350WIM
Housing	3851290019	RM1350M, RM1350MIM
Jet, cpl. No. 76	2007419332	RM1350, RM1350M RM1350 IM, RM1350MIM RM1350 WIM
Lamp (12V, 10W)	2007290006	RM1350, RM1350M RM1350IM, RM1350MIM RM1350WIM

# APPENDIX B - CONSUMER SUPPORT

## Dometic website

www.dometicusa.com

Please visit the website for information and news about Dometic products. You can obtain information about how to get in contact, learn about product care, download manuals, leaflets and warranties.

## Service and spare parts

For service, please contact the Service Center Assistance, see the front page of this manual - or - visit the Dometic website to find the location of the nearest Dometic Service Center.

Commonly used spare parts are listed in this manual, see APPENDIX A - SPARE PARTS. These should be available from your Dometic Service Center.

## Contact us

For contact information, please see the frontpage of this manual - or - visit the Dometic website.

## Register the appliance

www.edometic.com

Timely registration will allow for enhanced communication and service under the terms of the warranty, see APPENDIX C - DOMETIC WARRANTY & MAINTENANCE SCHEDULE.

To register the appliance, fill in the pre-printed registration card on the last page of this manual or register on-line at the Dometic website www.edometic.com.

TO REGISTER ON-LINE, FOLLOW THESE STEPS:

1. At www.edometic.com, click **Warranty Registration**.

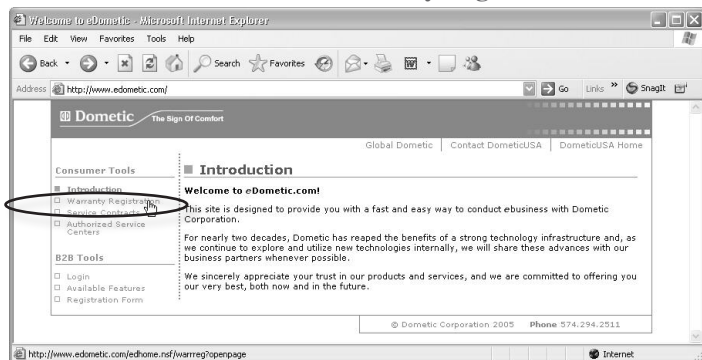

2. Click **Register your new Dometic product here**.



3. Complete the information and then, click the **Submit Registration** button.

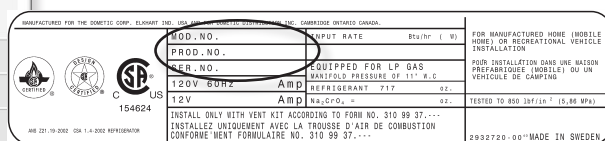

The model number (e.g. RM3762) and serial number (e.g. 012 34567) are stated on the data label in the refrigerator compartment.

# **IMPORTANT!**

## **Valuable Dometic Refrigerator Warranty & Maintenance Schedule**

Congratulations, and Thank You for purchasing the industry's best built and best backed RV Refrigerator. Enclosed you will find important warranty and maintenance information on Dometic's exclusive three (3) year warranty. Please take a few moments and familiarize yourself with the program. We at Dometic appreciate your business and are confident that you will have many years of trouble-free RV enjoyment.



## LIMITED THREE-YEAR WARRANTY DOMETIC REFRIGERATORS

### THE SELLER NAMED BELOW MAKES THE FOLLOWING WARRANTY WITH RESPECT TO THE DOMETIC PRODUCT:

1. This warranty is made only to the first purchaser (herein after referred to as the "Original Purchaser") who acquires the product for his own use and is installed and operated within the continental United States and Canada.
2. This warranty will be in effect for three years on parts and freight and two years on labor from the date of purchase by the Original Purchaser. It is suggested that the original purchaser retain a copy of the dated bill of sale as evidence of the date of purchase.
3. This warranty covers only specified parts, which shall be free from defects in material and workmanship under normal use. This warranty does not cover conditions unrelated to the material and workmanship of the product. Such unrelated conditions include, but are not limited to: (a) damage not reported within the first 7 days of ownership; (b) faulty installation or installation that does not comply with RVIA standards, and any damage resulting from such; (c) the need for normal maintenance and any damage resulting from the failure to provide such maintenance; (d) failure to follow Sellers instructions for use of product; (e) any accident to or misuse of any part of this product and any alteration by anyone other than the Seller or its authorized representative; (f) any non-Dometic parts that are installed as replacement parts will void any warranty (implied or written); (g) blow out conditions; (h) radio frequency interference and electromagnetic interference; (i) 12V system chassis ground decay and corrosion; (j) puncture of foam cabinet or vacuum insulated panels after acknowledged receipt; (k) animal or insect infiltration which damages unit or inhibits performance; (l) abuse or misuse of electrical components.
4. The specified parts covered by this warranty are as follows: Major components (cooling unit, LP gas valve, burner, burner housing, electronic display, electronic module, evaporator fins, foam integrity, frame, thermister, spark probe, ignition wire, icemaker compressor, second absorption loop, display escutcheon, lower toe plate, humidity switch, frame heater mullion, icemaker mullion) are covered for parts and freight for three years and labor for two years from date of purchase. All other components that fail must be reported within the first 90 days of ownership in order to receive coverage of parts, freight and labor under warranty.
5. **This warranty requires the Original Purchaser to provide preventative maintenance on a yearly basis, starting at the anniversary of his date of purchase.** The Original Purchaser must keep a record of the preventative maintenance to keep the warranty in effect. Failure of the Original Purchaser in providing this annual maintenance may void the warranty. The preventative maintenance must be performed at a Dometic Authorized Service Center/Dealer. The preventative maintenance required is an inspection, cleaning and full diagnostics performed on the entire electronic system, burner assembly, wiring and cooling unit. A copy of the receipt covering the maintenance checks must accompany the warranty claim during the second and third year of ownership. The cost of this preventative maintenance is the Original Purchaser's responsibility and should take about one hour.
6. In order to obtain the benefits of this warranty, the original purchaser must return the product which is found defective to the Seller named below or to a Dometic Authorized Service Center during the period that this warranty is in effect. The original purchaser is responsible for all charges incurred in delivery of the product to the Seller or Dometic Authorized Service Center, and in pick up after the warranty service has been completed. To obtain the location of the nearest Authorized Service Center, please call 1-800-544-4881 or in Canada call 1-519-720-9578.
7. Any item returned in the manner described in paragraph 6 will be examined by the Seller or the Authorized Dometic Service Center. If it is found that the returned item was defective in material and workmanship, the Seller or the Authorized Dometic Service Center will repair the product per the terms outlined in paragraph 4. **CONFIRM THE SERVICE AGENCY IS AN AUTHORIZED DOMETIC SERVICE CENTER. DO NOT PAY THE SERVICE AGENCY FOR WARRANTY REPAIRS. SUCH PAYMENTS WILL NOT BE REIMBURSED.**
8. The Seller does not authorize any person or company to create any warranty obligations or liability on their behalf. This warranty is not extended by the length of time which you are deprived of the use of the product. Repairs and replacement parts provided under the terms of this warranty shall carry only the non-expired portion of this warranty.
9. In no event shall either seller be liable for incidental or consequential damages. This includes any damage to another product or products resulting from such a defect. Some states do not allow the exclusion or limitation of incidental or consequential damages, so the above limitations may not apply.
10. Any implied warranty, including the implied warranty of merchantability and fitness for any purpose, is limited to the duration of this limited warranty. Some states do not allow limitations on how long an implied warranty can last, so the above limitation may not apply.
11. **THIS WARRANTY GIVE SPECIFIC LEGAL RIGHTS, YOU MAY ALSO HAVE OTHER RIGHTS WHICH VARY FROM STATE TO STATE.** No action to enforce this warranty shall be commenced later than ninety (90) days after the expiration of the warranty period. Claims must be submitted in writing to the Dometic Warranty Department for arbitration.
12. All products (except those specifically built for commercial use) are warranted only when installed on vehicles built to R.V.I.A and C.R.V.A, Z-240 Standards.
13. The Seller reserves the right to change the design of any product without notice and with no obligation to make corresponding changes in products previously manufactured.

**DOMETIC CORPORATION**  
Warranty Department  
2320 Industrial Parkway  
Elkhart, IN 46516  
Phone: 574-294-2511  
Fax: 574-293-9686

# REFRIGERATOR OWNER MAINTENANCE YEARLY RECORD

**Customer Name:** \_\_\_\_\_ **Model No.:** \_\_\_\_\_ **Date of Purchase:** \_\_\_\_\_  
**Address:** \_\_\_\_\_ **Serial No.:** \_\_\_\_\_  
**City:** \_\_\_\_\_ **State:** \_\_\_\_\_ **Zip Code:** \_\_\_\_\_  
**Phone:** \_\_\_\_\_

**FIRST YEAR**

Date: \_\_\_\_\_

Dealership: \_\_\_\_\_

\_\_\_\_\_

Address: \_\_\_\_\_

\_\_\_\_\_

City: \_\_\_\_\_

State: \_\_\_\_\_ Zip: \_\_\_\_\_

Phone: \_\_\_\_\_

Technician: \_\_\_\_\_

**SECOND YEAR**

Date: \_\_\_\_\_

Dealership: \_\_\_\_\_

\_\_\_\_\_

Address: \_\_\_\_\_

\_\_\_\_\_

City: \_\_\_\_\_

State: \_\_\_\_\_ Zip: \_\_\_\_\_

Phone: \_\_\_\_\_

Technician: \_\_\_\_\_

Cleaned Burner Assembly: Yes / No

Cleaned/Check All Terminals Connections: Yes / No

Cleaned/Inspect All Ground Connections: Yes / No

Inspect and Test Door Seals: Yes / No

Inspect and Tighten LP Lines: Yes / No

Power Ventilator Installed: Yes / No

\*Gas Safety Shutdown in 45 seconds: Yes / No

Cleaned Burner Assembly: Yes / No

Cleaned/Check All Terminals Connections: Yes / No

Cleaned/Inspect All Ground Connections: Yes / No

Inspect and Test Door Seals: Yes / No

Inspect and Tighten LP Lines: Yes / No

Power Ventilator Installed: Yes / No

\*Gas Safety Shutdown in 45 seconds: Yes / No

	ACTUAL	SPEC. RANGE
Electrode Gap	_____	3/16"
Thermister Reading	_____	7-10,000 ohms @ 32°
*D/C Voltage	_____	9.5 to 15 volts D/C
*A/C Voltage	_____	120 Volts ± 10%
Thermocouple Reading	_____	25-35 Millivolts
*Delay Between Modes	_____	Approx. 5 seconds

\* Use PAL RV Diagnostic Tool for these tests.

	ACTUAL	SPEC. RANGE
Electrode Gap	_____	3/16"
Thermister Reading	_____	7-10,000 ohms @ 32°
*D/C Voltage	_____	9.5 to 15 volts D/C
*A/C Voltage	_____	120 Volts ± 10%
Thermocouple Reading	_____	25-35 Millivolts
*Delay Between Modes	_____	Approx. 5 seconds

\* Use PAL RV Diagnostic Tool for these tests.

**ICEMAKER MODELS**

Inspect Water Valve and All Connections: Yes / No

Inspect Heat Tape Switch for Proper Operation: Yes / No

**ICEMAKER MODELS**

Inspect Water Valve and All Connections: Yes / No

Inspect Heat Tape Switch for Proper Operation: Yes / No

# PROTECTION FOR YOUR NEW INVESTMENT

We truly appreciate that you have chosen to purchase a Dometic product for your recreational vehicle and we want to help you protect this wise investment.

We at Dometic back our products with one of the most comprehensive warranties in the industry. Complete the registration card below and mail to us or register your Product on-line at [www.edometic.com](http://www.edometic.com).



**TIME-DATED  
MATERIAL**  
Please Process  
Promptly!

Tape  
here

FIRST  
CLASS  
POSTAGE  
REQUIRED

 **Dometic®**

Dometic Processing Center  
2320 Industrial Parkway  
Elkhart, IN 46516

Tape  
here

■ **WARRANTY VERIFICATION**

Your prompt registration records your right to protection under the terms and conditions of your warranty.

■ **OWNER CONFIRMATION**

Your completed Owner's registration card serves as confirmation of ownership in the event of product damage or theft.

■ **FACTORY COMMUNICATION**

Returning your card of registering on-line guarantees you will receive product information and specials. Leaving your email address below will allow us to communicate with you quickly and efficiently.

■ **3 PLUS 3 SERVICE CONTRACT**

Returning the card below or registering on-line assures you of an invitation to take advantage of an Optional 3 Plus 3 Full Service Contract which allows you to add up to 3 years of additional warranty coverage.



Return the card within **10** days to ensure your:

- WARRANTY VERIFICATION
- FACTORY COMMUNICATION
- OWNER CONFIRMATION
- 3 PLUS 3 SERVICE CONTRACT

*Fold here. Close with tape.*

**IMPORTANT:**  
Return Within  
10 days



**Owner's Registration Card**

Registering your product is an essential step to ensure that you receive all the benefits you are entitled to as a DOMETIC customer. Complete the information below and mail to us or register on-line at [www.edometic.com](http://www.edometic.com).

**Be sure to include your email address so that we can communicate with you quickly and efficiently. Your address will remain confidential and will not be distribute to third parties.**

Name

Address

City  Stat/Prov.

Date of Purchase    Zip/Postal Code   
MO DAY YEAR

Email Address

REFRIGERATOR MODEL NUMBER	SERIAL NUMBER
---------------------------	---------------

**TO THE INSTALLER**  
 PLEASE AFFIX THESE INSTRUCTIONS  
 TO THE REFRIGERATOR  
 —  
**TO THE CONSUMER**  
 PLEASE RETAIN THESE INSTRUCTIONS  
 FOR FUTURE REFERENCE