

# USER MANUAL

Please read this manual carefully before using this TV set and keep it for future reference.

# LCD TV

L3249

---

***Thank you for choosing Legend.  
Need help fast?***

Read your Quick Start Guide and User Manual first for quick tips and instructions on using your Legend product.

***IMPORTANT !!!***

If you have read the instruction manuals and still need assistance, please call us at the toll free number below.

**1-866-96 -LEGEND**

Mon. - Fri. 7:30am-5pm PST

	<b>CAUTION</b> RISK ELECTRIC SHOCK DO NOT OPEN	
<b>CAUTION:</b> TO REDUCE THE RISK OF ELECTRIC SHOCK, DO NOT REMOVE COVER (OR BACK). NO USER SERVICEABLE PARTS INSIDE. REFER SERVICING TO QUALIFIED SERVICE PERSONNEL.		

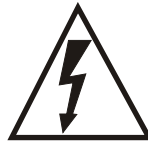

The lightning flash with arrowhead symbol, within an equilateral triangle is intended to alert the user to the presence of uninsulated dangerous voltage within the product's enclosure that may be of sufficient magnitude to constitute a risk of electric shock.



The exclamation point within an equilateral triangle is intended to alert the user to the presence of important operating and maintenance (servicing) instructions in the literature accompanying the appliance.

**WARNING:** TO PREVENT FIRE OR SHOCK HAZARD, DO NOT EXPOSE THIS APPLIANCE TO RAIN OR MOISTURE.

**CAUTION:** TO PREVENT ELECTRIC SHOCK DO NOT USE THIS POLARIZED PLUG WITH AN EXTENSION CORD, RECEPTACLE OR OTHER OUTLET UNLESS THE BLADES CAN BE FULLY INSERTED TO PREVENT BLADE EXPOSURE.

**CAUTION:** These servicing instructions are for use by qualified service personnel only. To reduce the risk of electric shock, do not perform any servicing other than that contained in the operating instructions unless you are qualified to do so.

## Important Safety Instructions

- 1) Read these instructions.
- 2) Keep these instructions.
- 3) Heed all warnings.
- 4) Follow all instructions.
- 5) Do not use this apparatus near water.
- 6) Clean only with dry cloth.
- 7) Do not block any ventilation openings. Install in accordance with the manufacturer's instructions.
- 8) Do not install near any heat sources such as radiators, heat registers, stoves, or other apparatus (including amplifiers) that produce heat.
- 9) Do not defeat the safety purpose of the polarized or grounding-type plug. A polarized plug has two blades with one wider than the other. A grounding type plug has two blades and a third grounding prong. The wide blade or the third prong are provided for your safety. If the provided plug does not fit into your outlet, consult an electrician for replacement of the obsolete outlet.
- 10) Protect the power cord from being walked on or pinched particularly at plugs, convenience receptacles, and the point where they exit from the apparatus.
- 11) Only use attachments/accessories specified by the manufacturer.
- 12) Use only with the cart, stand, tripod, bracket, or table specified by the manufacturer, or sold with the apparatus. When a cart is used, use caution when moving the cart/ Apparatus combination to avoid injury from tip-over.
- 13) Unplug this apparatus during lightning storms or when unused for long periods of time.
- 14) Refer all servicing to qualified service personnel. Servicing is required when the apparatus has been damaged in any way, such as power-supply cord or plug is damaged, liquid has been spilled or objects have fallen into the apparatus, the apparatus has been exposed to rain or moisture, does not operate normally, or has been dropped.
- 15) The apparatus shall not be exposed to dripping or splashing and that no objects filled with liquids, such as vases, shall be placed on the apparatus.
- 16) The mains plug or appliance inlet is used as the disconnect device, remain it readily operable during the apparatus normal use.



Class I apparatus shall be connected to a mains socket outlet with a protective earthing connection.

# Contents

## Introduction

Controls . . . . .	1
Connection Options . . . . .	2
Universal Remote control . . . . .	3

## External Equipment Connections

Accessories . . . . .	4
Antenna Connection . . . . .	4
Connecting a VCR . . . . .	5
External A/V Source Setup . . . . .	6
Connecting a DVD player . . . . .	6
Connecting a DTV(digital TV) . . . . .	7
Connecting digital audio output . . . . .	7
Connecting a computer . . . . .	8
Monitor Out Setup . . . . .	9
HDMI and DVI input . . . . .	9
Cable sample . . . . .	10
Connecting Headphones . . . . .	11
Power source . . . . .	11
Removing the tablestand and installing a wall mount bracket . . . . .	12

## Operation

Switching On/Off the TV set . . . . .	13
Choose the Menu Language . . . . .	13
Choose the input source . . . . .	13

## Channel Menu

Channel Scan . . . . .	14
Channel Skip . . . . .	14
Channel Label . . . . .	14
Select the desired program . . . . .	15
Select the desired sound . . . . .	15
Mute . . . . .	15

## Video Menu

How to select picture mode . . . . .	16
How to customize your own picture status . . . . .	16
PC Set . . . . .	17

## Audio Menu

How to select audio mode . . . . .	18
How to customize your own audio status . . . . .	18
SAP Broadcasts Setup . . . . .	18

## Function Menu

Menu Language . . . . .	19
OSD Timeout . . . . .	19
OSD Transparency . . . . .	19
Screen Mode . . . . .	19
Blue Screen . . . . .	20
DPMS . . . . .	20
Time zone setting . . . . .	20
Date /Time setting . . . . .	20
Sleep Timer setting . . . . .	21
DTV Caption Style . . . . .	21

## Lock Menu

Parental Control rating and categories . . . . .	22
Lock setup . . . . .	23

## Other Functions

Brief Info . . . . .	25
Using the Guide . . . . .	25
Quick program view . . . . .	26
CC (Closed Caption Display) . . . . .	26
USB Input . . . . .	27

## Universal Remote Control

Setting up your remote control . . . . .	29
Remote Control Codes . . . . .	31

<b>Maintenance</b> . . . . .	37
------------------------------	----

<b>Product Specification</b> . . . . .	38
--	----

<b>Troubleshooting</b> . . . . .	49
----------------------------------	----

<b>Warranty</b> . . . . .	40
---------------------------	----

# Controls

This is a simplified representation of the TV front panel, side panel control buttons and side inputs.

## TV Side panel controls and connections

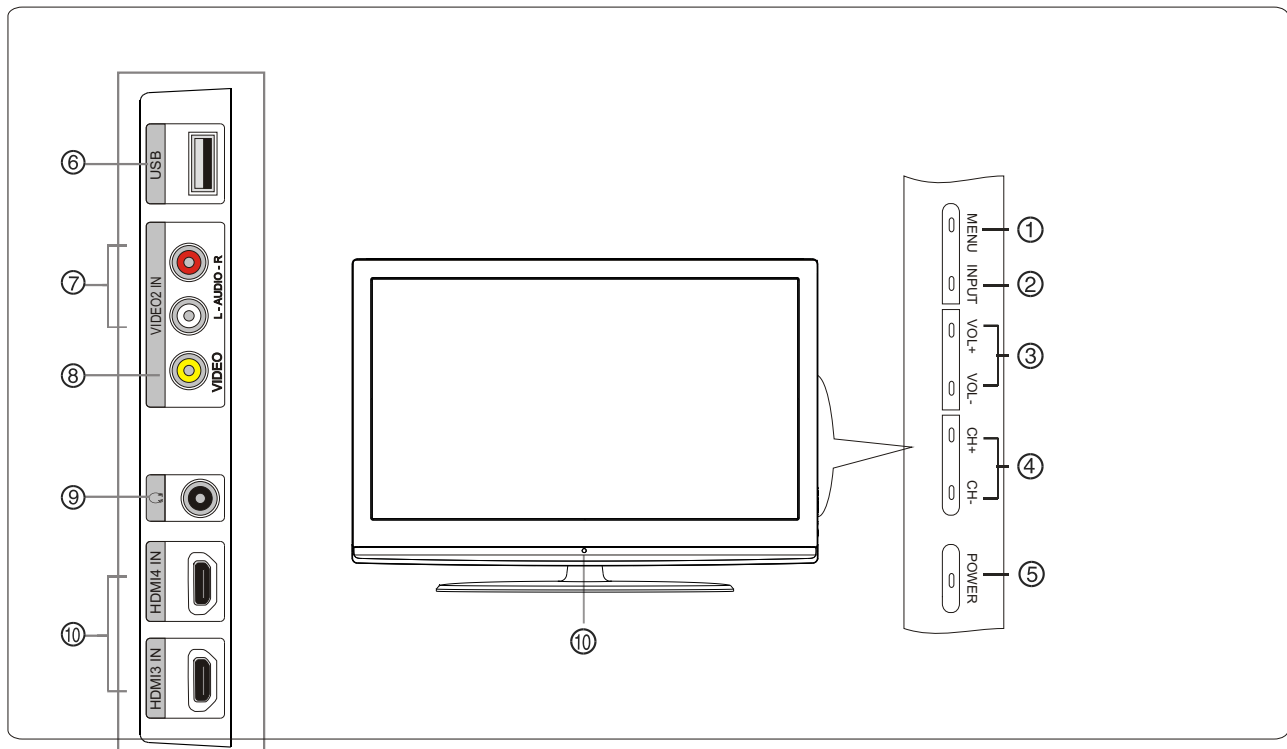

1. **MENU**: Menu display. Press to access the on-screen menu display
2. **INPUT**: Press to access the input source mode. Press repeatedly to change the source to the one you want to watch. In the **MENU** screen, the **INPUT** button serves as the **ENTER** button.
3. **VOL +/-**: Press to adjust the volume. In the **MENU** screen, these buttons serve as left/right buttons.
4. **CH +/-**: Press to scan through channels. To scan quickly through channels, press and hold down either +/- . In the **MENU** screen, these buttons serve as up/down buttons.
5. **POWER**: Press to turn on and off the TV.
6. **USB input**: Connect a USB flash drive to view JPEG images or listen to MP3 songs.
7. **Av2 AUDIO IN**: Connect the audio L/R cables from the video signal source to these jacks.
8. **AV2 VIDEO IN**: Connects the composite video cable from an external signal source to this jack.
9. **Headphone jack** : Headphone audio output terminal.
10. **HDMI IN**: Connect a HDMI device to receive digital audio and uncompressed digital video signals.
11. **Remote Sensor** : Receives IR signals from the remote control.  
Do not put anything near the sensor , which may block the remote control signal.

# Connection Options

## Back panel connections

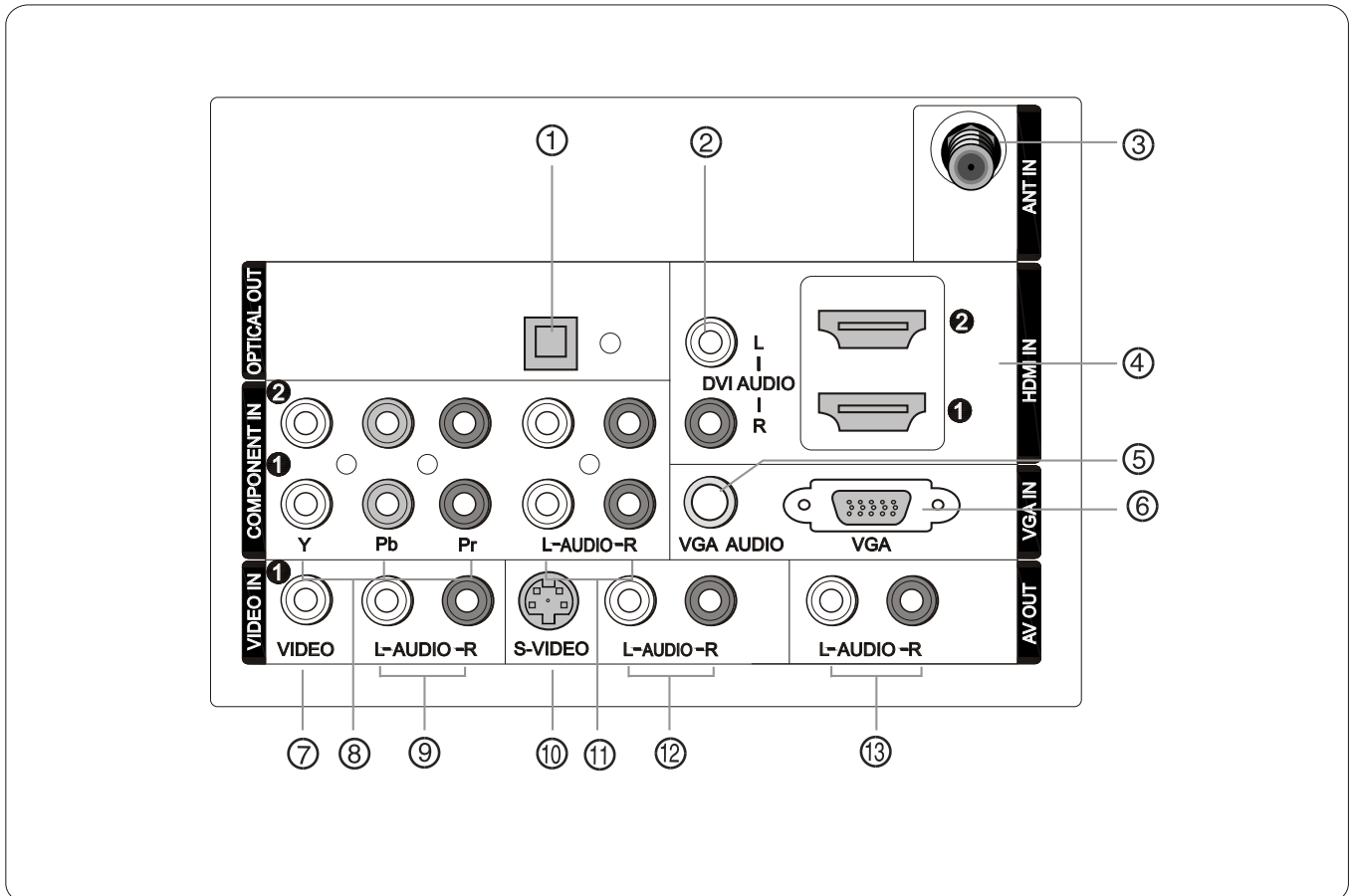

1. **Digital Audio Output:** Connect various types of digital audio equipment.

**NOTE:** In standby mode, these ports will not work.

2. **DVI Audio In:** When using a DVI to HDMI adapter, connect the audio signal to these jacks.

3. **Antenna Input:** Connect cable or antenna signals to the TV, either directly or through your cable box.

4. **HDMI In:** Connect a HDMI device to receive digital audio and uncompressed digital video.

5. **VGA Audio In:** Connect the audio L/R cables from a computer to this jack.

6. **VGA Video In:** Connect a video cable from a computer to this jack.

7. **VIDEO In:** Connects the video signal from a video device.

8. **Component Video In:** Connect a component video device to these jacks.

9. **AUDIO In:** Connect the audio L/R cables from the video signal source to these jacks.

10. **S-VIDEO In:** Connect the S-Video cable from an external signal source to this jacks.

11. **COMPONENT AUDIO In:** Connect the audio L/R cables from the component video signal source to these jacks.

12. **AUDIO In:** Connect the audio L/R cables from the S-Video signal source to these jacks.

13. **AUDIO Out:** Connect the audio L/R cables to your audio equipment.

# Universal Remote control

The remote control cannot be operated unless the batteries are properly loaded.  
When using the remote control, aim it at the remote sensor on the TV.

## Function introduction

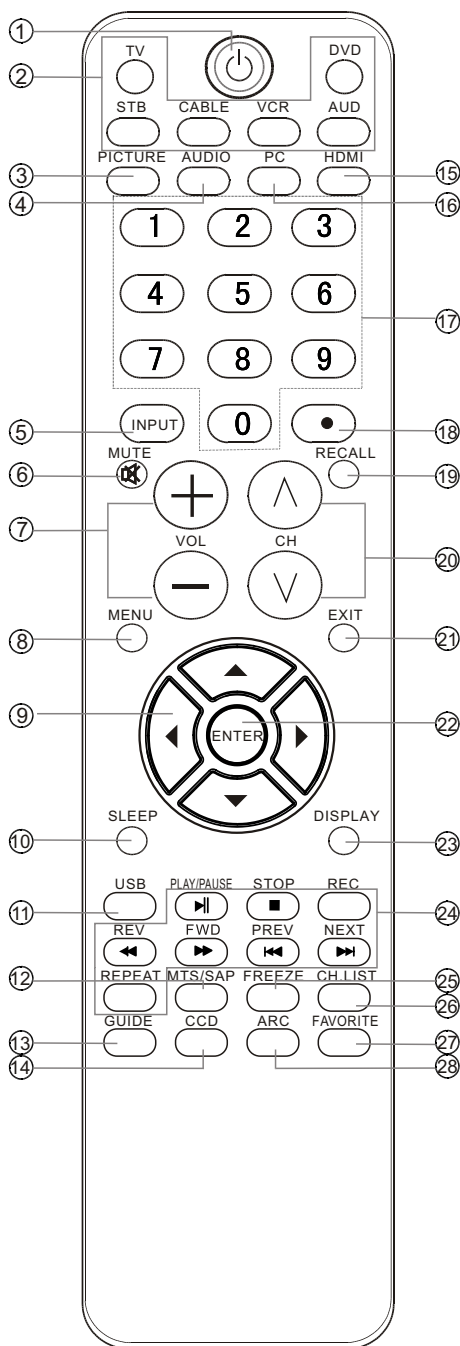

1. **POWER**  
Press to turn on and off the TV.
2. **TV DVD SETBOX CABLE VCR AUD**  
To select one of the system modes in which the remote control can be used.
3. **PICTURE**  
Press repeatedly to cycle through the available picture modes.
4. **AUDIO**  
Press to cycle through different sound settings.
5. **INPUT**  
Show the input source.
6. **MUTE**  
Switches the video sound on or off.
7. **VOLUME UP/DOWN**  
Press to adjust the volume.
8. **MENU**  
Press to open the on-screen menu.
9. **THUMBSTICK (Up/Down/Left/Right)**  
Allows you to navigate the on-screen menus and adjust the system settings to your preference.
10. **SLEEP button**  
Press to display the sleep timer option.
11. **USB:** Press to switch input source to USB in.
12. **MTS/SAP**  
Selects MTS sound: Mono, Stereo, and SAP in Analog mode. Change the audio language in DTV mode.
13. **GUIDE**  
Press to display the guide when you are watching analog or digital channels.
14. **CCD(closed caption)**  
Select a closed caption.
15. **HDMI:** Press to select a device connected to the HDMI input
16. **PC:** Press to select the computer connected to the VGA input
17. **Number buttons**  
Press to change a channel.
18. **. button**  
Press to select digital channels. For example, to enter "54-3", press "54", ".", and "3".
19. **RECALL**  
Press to jump back and forth between two channels.
20. **CHANNEL UP/DOWN**  
Press to scan through channels. To scan quickly between the last two channels, press and hold down either +/-.
21. **EXIT**  
Clears all on-screen displays and returns to TV viewing from any menu.
22. **ENTER**  
Accesses the highlighted item in the on-screen menu
23. **DISPLAY**  
Press to display the TV status information on the top of the TV screen.
24. **USB Functions**  
Control the USB System.  
 ◀▶▶▶ Rewind / Fast   ▶▶▶▶ backward / Forward  
 ■ Stop   ▶▶ Play/Pause   ● REC   REPEAT Repeat
25. **FREEZE**  
Press once to display a frozen image of the current program, but audio continues. Press again to return to the program.
26. **CH.LIST**  
Open the channel list in TV.
27. **FAV.LIST**  
Press to open the favorite channel list in TV.
28. **ARC(Aspect Ratio Control)**  
Press to change the aspect ratio.

# External Equipment Connections

## Accessories

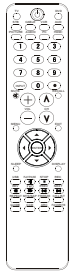

Remote control

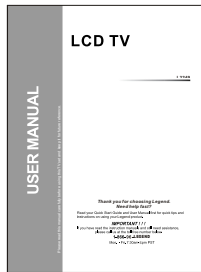

Owner`s manual

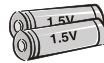

Alkaline battery(AAA)×2

## Antenna Connection

Over-the-air TV reception quality will depend on your antenna type, antenna location and antenna positioning.

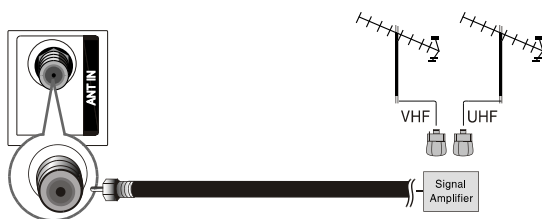
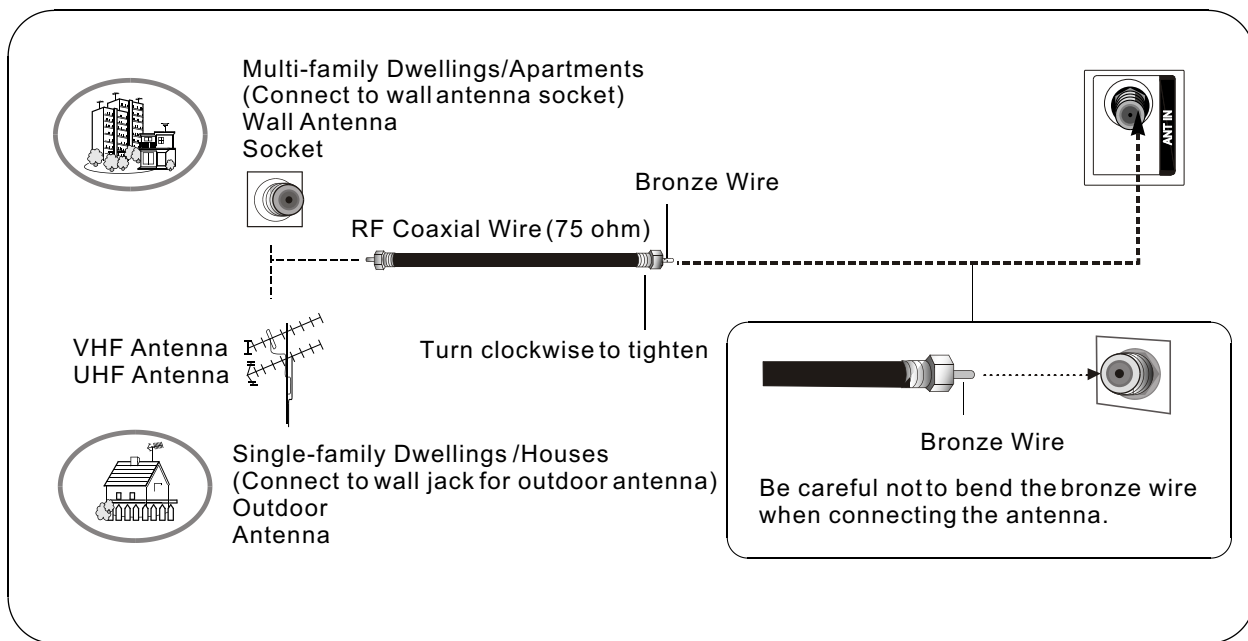

- To improve the picture quality in a poor signal area, please purchase a signal amplifier and install properly.
- If the antenna needs to be split for two TV`s, install a "2-Way Signal Splitter" in the connections.
- To install the antenna properly please contact a professional in your area.

# External Equipment Connections

**NOTE:** All cables shown are not included with the TV.

## Choose Your Connection

There are several ways to connect your television, depending on the components you want to connect and the quality of the signal you want to achieve. The following are examples of some different ways to connect your TV with different input sources.

## Connecting a VCR

To avoid picture noise (interference), leave an adequate distance between the VCR and TV.

### Connection Option 1

Set VCR output switch to channel 3 or 4 and then tune the TV to the same channel number.

### Connection Option 2

1. Connect the audio and videocables from the VCR's output jacks to the TV input jacks, as shown in the figure. When connecting the TV to VCR, match the jack colors (Video = yellow, Audio Left = white, and Audio Right = red). If you connect a S-VIDEO output from VCR to the S-VIDEO input, the picture quality is improved; compared to connecting a regular VCR to the Video input.

2. Insert a video tape into the VCR and press PLAY on the VCR. (Refer to the VCR owner's manual.)

3. Select the input source with using the **INPUT** button on the remote control, and then press **▲ / ▼** button to select the source, press **ENTER** button to confirm.

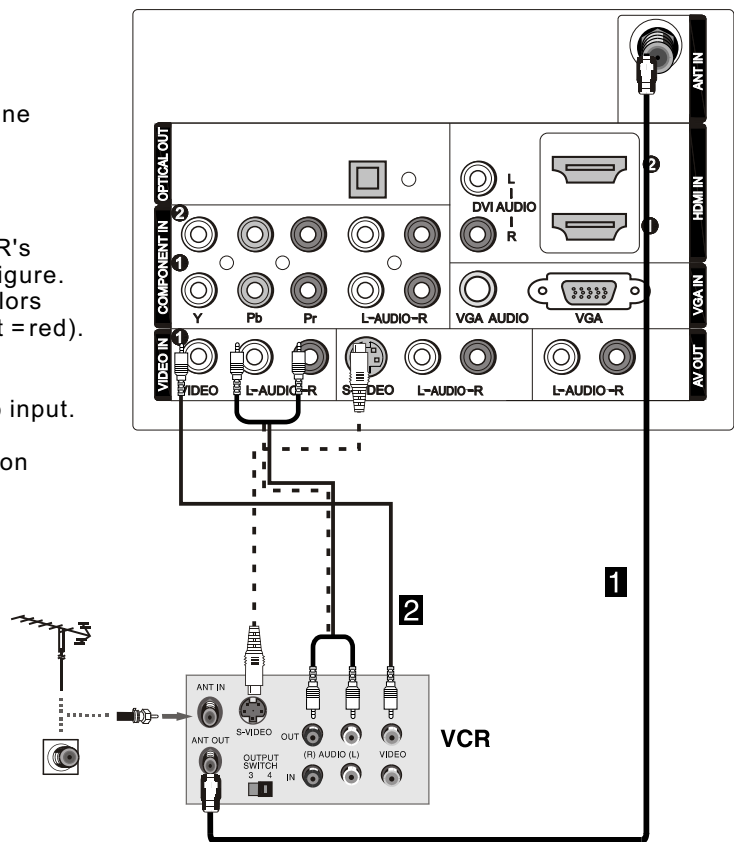



# External Equipment Connections

## External A/V Source Setup

### How to connect

Connect the audio and video cables from the external equipment's output jacks to the TV input jacks, as shown in the figure.

When connecting the TV to external equipment, match the jack colors (Video = yellow, Audio Left = white, and Audio Right = red).

### How to use

1. Select the input source with using the INPUT button on the remote control.
2. Press ▲/▼ button to select the desired source.
3. Press ENTER button to confirm.
4. Operate the corresponding external equipment.

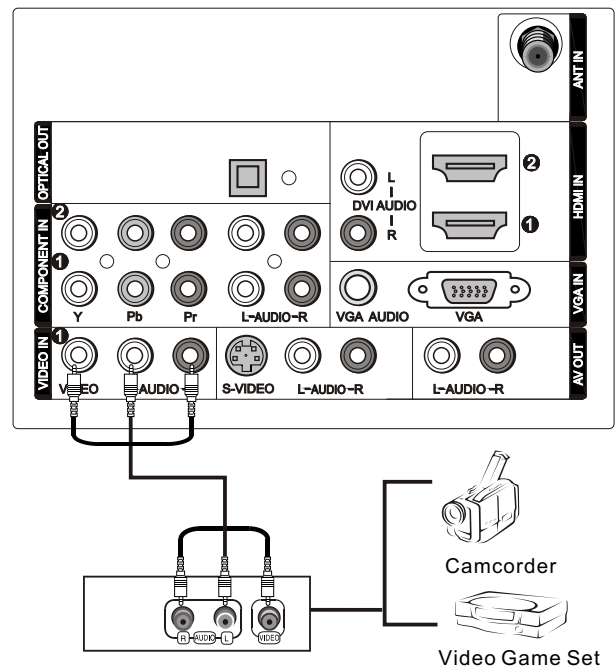

## Connecting a DVD player

### How to connect

1. Connect the DVD video outputs (COMPONENT) to the YPbPr jacks on the TV and connect the DVD audio outputs to the YPbPr Audio IN jacks on the TV, as shown in the figure.
2. If your DVD only has an S-VIDEO output jack, connect this to the S-VIDEO input on the TV, as shown in the figure.

### Note

If your DVD player does not have component video output, use S-Video.

### How to use

1. Turn on the DVD player, insert a DVD.
2. Use INPUT button on the remote control to select component mode.
3. Press Play button on external equipment for program play.
4. Refer to the DVD player's manual for operating instructions.

### ■ Component Input ports

To get better picture quality, connect a DVD player to the component input ports as shown below.

Component ports on the TV	Y	Pb	Pr
Video output ports on DVD player	Y	Pb	Pr
	Y	B-Y	R-Y
	Y	Cb	Cr
		P <sub>B</sub>	P <sub>R</sub>

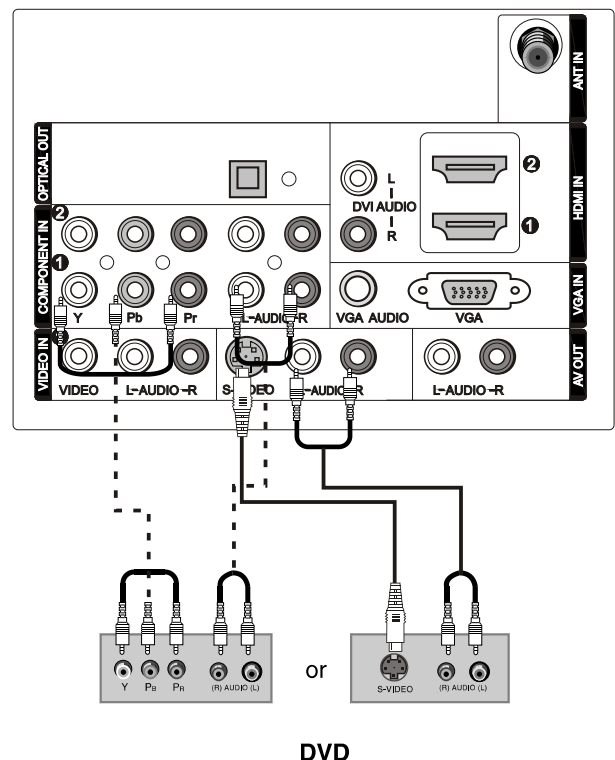

# External Equipment Connections

## Connecting a DTV(digital TV)

This TV can receive Digital Over-the-air/Cable signals without an external digital set-top box. However, if you do receive Digital signals from a digital set-top box or other digital external device, refer to the figure as shown below. This TV supports HDCP (High-bandwidth Digital Contents Protection) protocol for Digital Contents (480p, 720p, 1080i).

### How to connect

Use the TV's COMPONENT, VGA or HDMI jack for video connections, depending on your set-top box connector. Then, make the corresponding audio connections.

### How to use

1. Turn on the digital set-top box. (Refer to the owner's manual for the digital set-top box.)
2. Use **INPUT** on the remote control to select COMPONENT, VGA or HDMI source.

Signal	COMPONENT	HDMI
480i	Yes	Yes
480p	Yes	Yes
720p	Yes	Yes
1080i	Yes	Yes
1080p	Yes	Yes

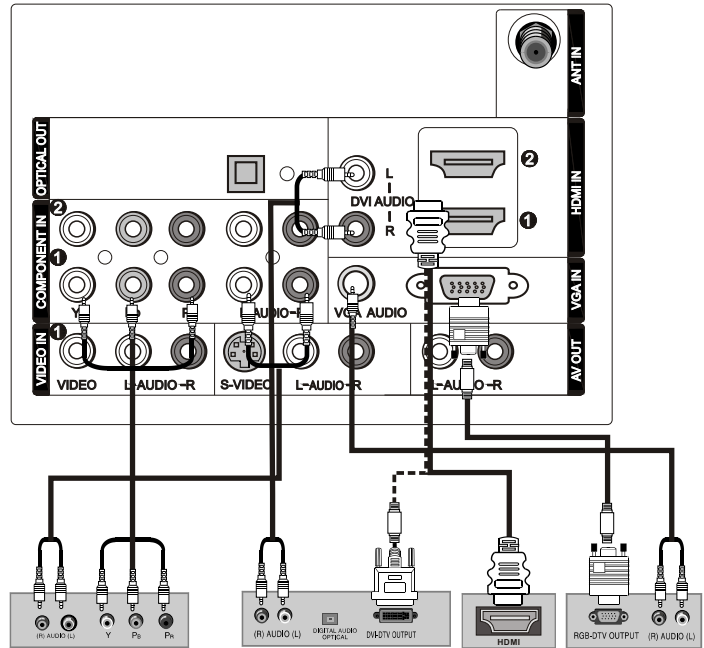

Digital Set-top Box

## Connecting a digital audio output

Send the TV's audio to external audio equipment (stereo system) via the Digital Audio Output (Optical) port.

### How to connect

1. Connect one end of an optical cable to the TV Digital Audio(Optical) Output port.
2. Connect the other end of the optical cable to the digital audio (optical) input on the audio equipment. See the external audio equipment instruction manual for operation.

### Note

When connecting with external audio equipments, such as amplifiers or speakers, please turn the TV speakers off.



**Caution:** Do not look into the optical output port. Looking at the laser beam may damage your vision.

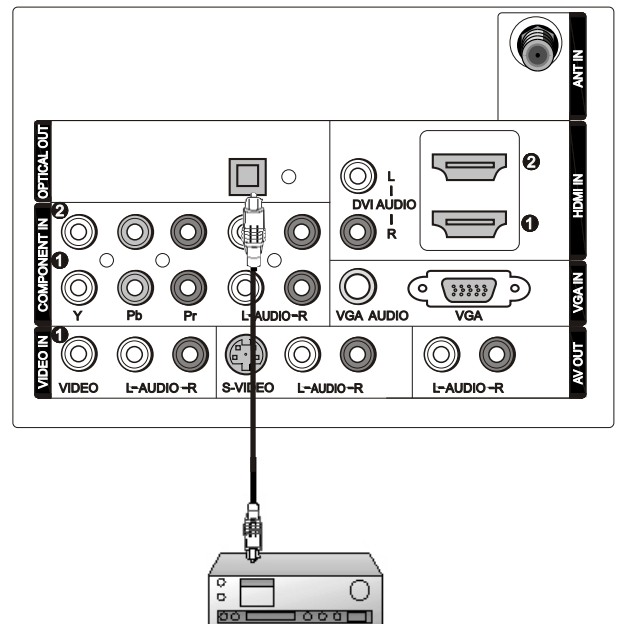

# External Equipment Connections

## Connecting a computer

### How to connect

1. To get the best picture quality, adjust the VGA graphics card to 1024x768.
2. Use the TV's VGA or DVI (Digital Visual Interface) Audio IN port for audio connections, depending on your computer connector.
  - If the graphic card on the computer does not output analog and digital RGB simultaneously, connect only one of either VGA IN or HDMI IN to display the VGA on the TV.
  - If the graphic card on the computer does output analog and digital RGB simultaneously, set the TV to either VGA or HDMI; (the other mode is set to Plug and Play automatically by the TV.)
3. Then, make the corresponding audio connection. If using a sound card, adjust the VGA sound as required.

### How to use

1. Turn on the computer and the TV.
2. Use INPUT on the remote control to select VGA or HDMI source.
3. Check the image on your TV. There may be noise associated with the resolution, vertical pattern, contrast or brightness in VGA mode. If noise is present, change the VGA mode to another resolution, change the refresh rate to another rate or adjust the brightness and contrast on the menu until the picture is clear. If the refresh rate of the VGA graphic card cannot be changed, change the VGA graphic card or consult the manufacturer of the VGA graphic card.

### Note

1. Use a DVI cable.
2. Avoid keeping a fixed image on the TV's screen for a long period of time. The fixed image may become permanently imprinted on the screen.
3. The synchronization input form for Horizontal and Vertical frequencies is separate.

### Resolution

Mode	Resolution	Frame frequency (Hz)
VGA	640x480	60Hz
SVGA	800x600	60Hz
		75Hz
XGA	1024x768	60Hz
		75Hz

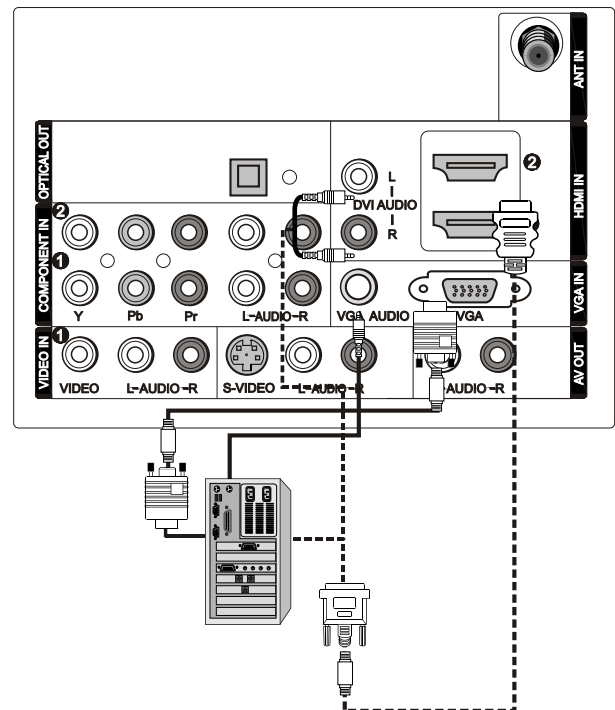

---

# External Equipment Connections

## HDMI and DVI input

### When the source device(DVD player or Set Top Box) supports HDMI

#### How To Connect

1. Connect the source device to HDMI port of this TV with an HDMI cable(not supplied with this product).
2. No separated audio connection is necessary.

#### How To Use

If the source device supports Auto HDMI function, the output resolution of the source device will be automatically set to 1280x720p.

If the source device does not support Auto HDMI, you need to set the output resolution appropriately.

To get the best picture quality, adjust the output resolution of the source device to 1280x720p.

Select HDMI input source in input source option of Select Main source menu.

### When the source device(DVD player or Set Top Box) supports DVI

#### How To Connect

1. Connect the source device to HDMI port of this TV with a HDMI-to-DVI cable(not supplied with this product).
2. A separated audio connection is necessary.
3. If the source device has an analog audio output connector, connect the source device audio output to DVI Audio In port located on the left side of HDMI port.

#### How To Use

If the source device supports Auto DVI function, the output resolution of the source device will be automatically set to 1280x720p.

If the source device does not support Auto DVI, you need to set the output resolution appropriately.

To get the best picture quality, adjust the output resolution of the source device to 1280x720p.

Press the INPUT button to select HDMI input source in input source option of Select Main source menu.

## Cable sample

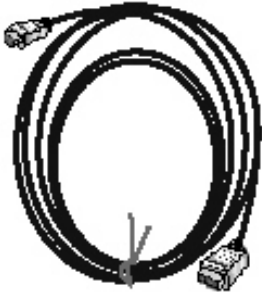

HDMI Cable  
(not supplied with the product)

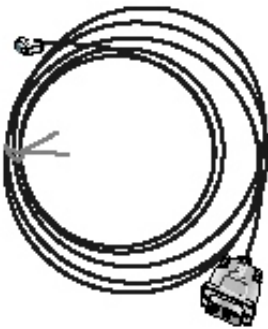

HDMI to DVI Cable  
(not supplied with the product)

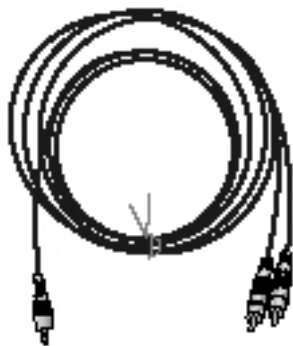

Analog Audio Cable  
(Stereo to RCA type)  
(not supplied with the product)

## External Equipment Connections

### Connecting Headphones

You can connect a set of headphones to your set if you wish to watch a TV programme without disturbing the other people in the room.

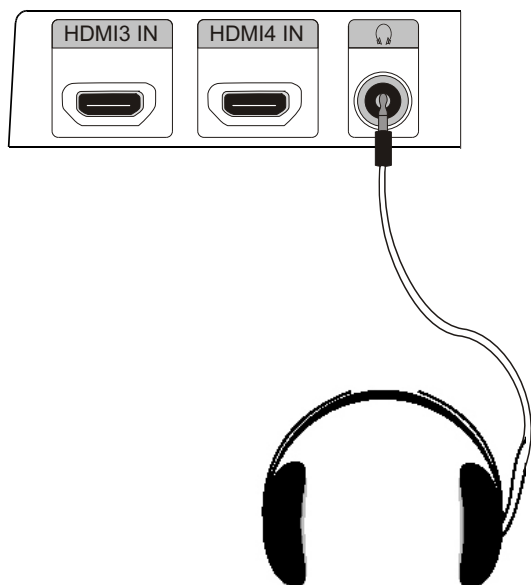

Plug a set of headphones into the 3.5mm mini-jack socket on the side panel of the set.

#### Note

- Prolonged use of headphones at a high volume may damage your hearing.
- You will not receive sound from the speakers when you connect headphones to the system.

### Power source

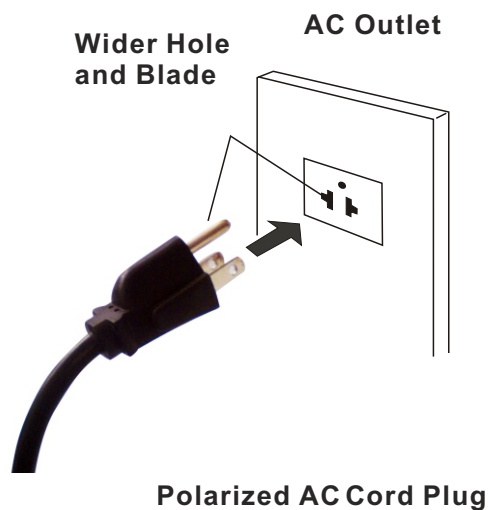

#### TO USE AC POWER SOURCE

Use the AC polarized line cord provided for operation on AC. Insert the AC cord plug into a standard polarized AC outlet.

#### Note

- Never connect the AC line cord plug to other than the specified voltage. Use the attached power cord only.
- If the polarized AC cord does not fit into a non-polarized AC outlet, do not attempt to file or cut the blade. It is the user's responsibility to have an electrician replace the obsolete outlet.
- If you cause a static discharge when touching the unit and the unit fails to function, simply unplug the unit from the AC outlet and plug it back in. The unit should return to normal operation.

## Removing the table stand and installing a wall mount bracket

HL42XK1

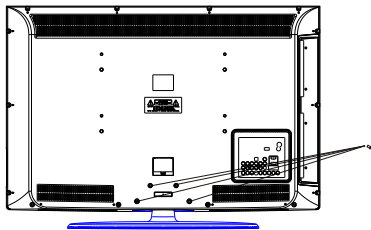

Remove 4X M4 screws securing the stand to the TV, then remove the stand.

HL26R1(4X M4), HL32R1(5X M4),  
HL42XR1(4X M4), HL26K1(4X M4),  
HL32K1(4X M4), HL32XK1(4X M4),  
HL32P1(4X M4)

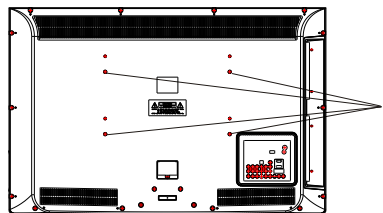

Use 4X M6 screws to secure the wall bracket (not supplied) to the back of your TV.

HL26R1(4X M4), HL32R1(4X M4),  
HL42XR1(4X M4), HL26K1(4X M4),  
HL32K1(4X M4), HL32XK1(4X M4),  
HL32P1(4X M4)

# Operation

In the manual, the OSD (on screen display) may be different from your TV's, because it is just an example to help you with the TV operation.

There are several options you might need to set up in order for your TV to work properly. Read the instructions that follow.

Initial Setup: Set according to the screen display.

## Switching On/Off the TV set

1. First, connect power cord correctly.
2. Select the viewing source by using **INPUT** button on the remote control.
3. When finished using the TV, press **POWER** button on the remote control. The TV reverts to standby mode.
4. If you intend to be away on vacation, disconnect the power plug from the wall power outlet.

### Note

If the TV is power on, the screen shows information according to the type of input signal. The information will disappear. If there is no signal, "No Signal" will display on the screen.

## Choose the Menu Language

When you start using your set for the first time, you must select the language which will be used for displaying menus and indications.

1. Choose **TV** Input and then press **MENU** button.
2. Press **▲/▼** button to select **Function** menu.
3. Press **▶/ENTER** button and then use **▲/▼** button to select **Language**.
4. Press **◀/▶** button to select language.  
(English, Spanish or French)

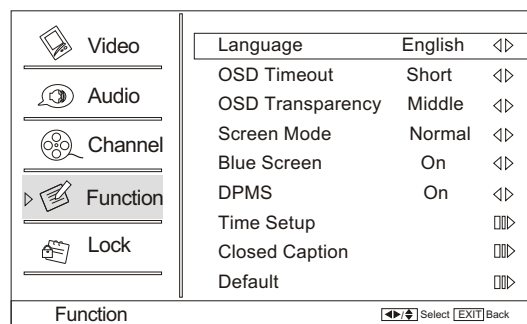

## Choose the Input source

Change the picture source so you can watch your TV, VCR, DVD, Cable, or any other devices that are connected to your TV.

1. Press **INPUT** button to enter the Select Source menu and then use **▲/▼** button to select the desired items (TV, Video1, Video2, S-Video, Component1, Component2, PC, HDMI1, HDMI2, HDMI3, HDMI4).
2. Press **ENTER** button to confirm.

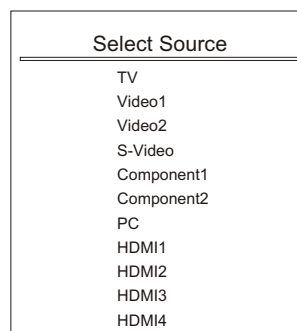



# Channel menu

■ This TV set has two methods to set channels, which are respectively Channel Scan, Channel Skip.

■ In this section, how to use the remote control to set channel is explained. You can also use buttons on the TV to set channel.

**Note**

The Channel menu will be only operated in normal TV mode.

## Channel Scan

1. Press **MENU** button and then use **▲/▼** button to select **Channel** menu.
2. Press **▶/ENTER** button to select **Tuner**.
3. Press **◀/▶** button to select **Cable** or **Antenna** mode.
4. Press **▲/▼** button to select **Channel Scan**.
5. Press **▶/ENTER** button to start searching.
6. To cancel searching, press **EXIT** button.

**Note**

When **Antenna** is selected, the TV will detect antenna signals and will search for antenna TV (NTSC and ATSC) channels available in your local area.

When **Cable** is selected, the TV will detect cable company supplied signals and will search for cable TV (NTSC, QAM modulated) channels available in your Area.

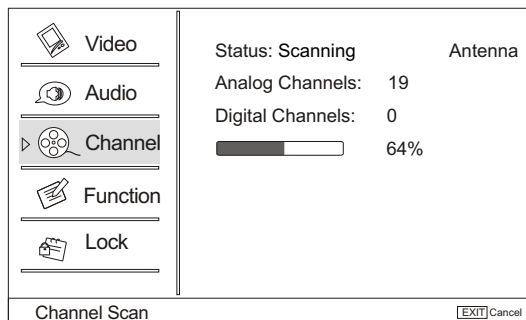
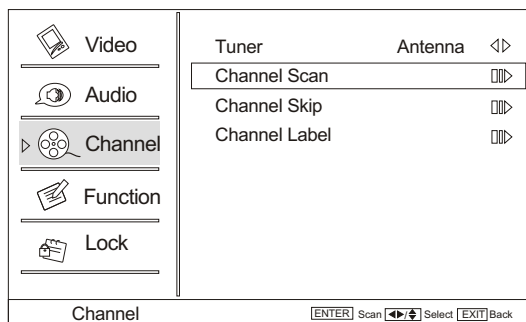

## Channel Skip

A skip channel is skipped when using **▲/▼** button to browse the channels. A skip channel can be watch by key-in the channel number or select by list.

Default un-scanned analog channels are skip.

Channel with a check icon  is a skipped channel.

1. Press **MENU** button and then use **▲/▼** button to select **Channel** menu.
2. Press **▶/ENTER** button and then use **▲/▼** button to select **Channel Skip**.
3. Press **▲/▼** button to select a channel, then press **ENTER** button to toggle between  and .

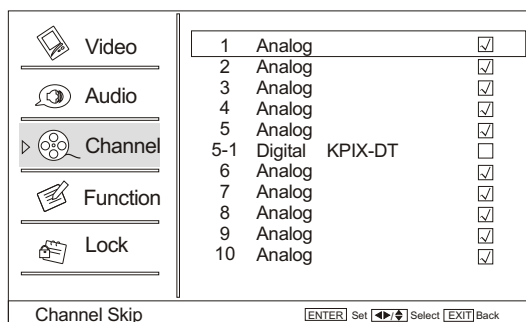

## Channel Label

Allows you to name the channel that is selected.

Press **▶/ENTER** button to enter the submenu.

Then press **▲/▼** to select **Channel Index** and **Channel Label** and **◀/▶** to select the position of the item that you want to change, afterward press **INPUT** to input the numbers and symbols and **ENTER** button to confirm.

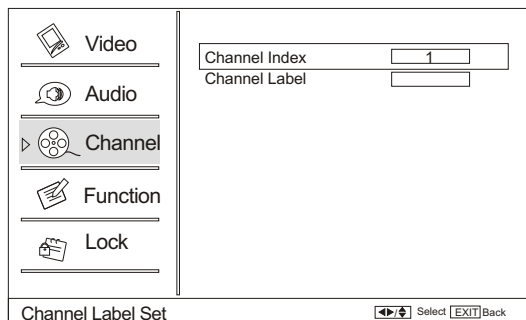

---

## Select the desired program

---

1. Using **CH+/-** buttons.

■ Press **CH+** button to select a channel number in number increasing direction.

■ Press **CH-** button to select a channel number in number decreasing direction.

### Note

If skip is ON on one channel, press **CH+/-** button, the channel will not appear.

2. Also can enter channel number directly, eg: 2-0.

---

## Select the desired sound

---

Press **VOL-/+** buttons on the remote or the front of the TV set to adjust the volume level. The range is 0~100. When the volume buttons are pressed the volume level is displayed automatically on the TV screen.



---

## Mute

---

1. Press **MUTE** button on the remote control and “” icon will display on the screen. At this time, the sound of the TV set is turned off.

2. If you want to recover the sound, press **MUTE** button again or directly press **VOL+** button.

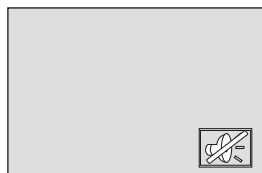

## Video menu

The TV menu gives you an overview of the menus you can select.

### Note

Depending on the input signal, one or more menu items may not be selectable.

## How to select picture mode

The picture mode provides the pre-defined images settings: Standard, Vivid, Custom and Mild .

1. Press **MENU** button and then use ▲ / ▼ button to select **Video** menu.
2. Press ► / **ENTER** button and then use ▲ / ▼ button to select **Mode**.
3. Press ◀ / ▶ button to select the option Standard, Vivid, Custom and Mild.

You can also press **PICTURE** button on the remote control to select the option Standard, Vivid, Custom and Mild.

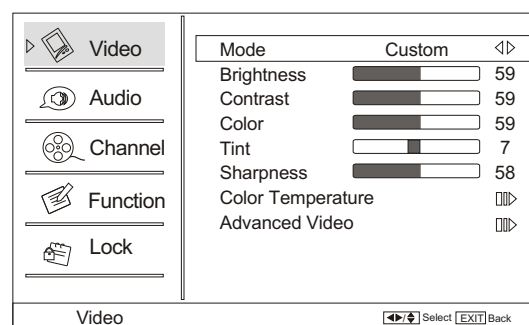

## How to customize your own picture status

1. Press **MENU** button and then use ▲ / ▼ button to select **Video** menu.
2. Press ► / **ENTER** button and then use ▲ / ▼ button to select the desired items.
3. Press ► / **ENTER** button and then use ◀ / ▶ button to adjust the setting.

### ■ Mode

Select the mode of picture(Standard/ Vivid/ Custom/ Mild).

### ■ Brightness

This will adjust the light output of the complete picture, which will mainly affect the darker areas of the picture.

### ■ Contrast

This will adjust the intensity of bright parts in the picture but keep the dark parts unchanged.

### ■ Color

This will adjust the saturation level of the colors to suit your personal preference.

### ■ Tint

Allows you to select the color mix (Tint) of the picture.

### ■ Sharpness

This will adjust the sharpness of fine details in the picture.

### Note

Only when the item of mode is custom , the Brightness, Contrast, Color, Tint, Sharpness and Color Temperature can be set by user . In other mode the value of them are preset.

## Video menu

### ■ Color temperature

This will increase or decrease Warm (red) and Cool (blue) colors to suit personal preferences.

Select Cool to give the white colors a blue tint, Standard to give the white colors a neutral tint, Warm to give the white colors a red tint.

### ■ Advanced Video

To adjust the picture in advanced: DNR, Black Level Extender, White Peak Limiter, CTI, Flech Tone, Adaptive Luma Control.

#### ■ DNR

To adjust reduce the appearance of digitizing error by the compression: Off, Weak, Medium, Strong, Auto.

#### ■ Black Level Extender

To adjust the ability in the black areas detail of the picture: On and Off.

#### ■ White Peak Limiter

To adjust the ability in the white areas detail of the picture: On and Off.

#### ■ CTI

To adjust the picture for color errors: Off, Weak, Medium and Strong.

#### ■ Flesh Tone

To adjust the flesh color: On and Off.

#### ■ Adaptive Luma Control

To adjust changes in the luminance of the picture: On and Off.

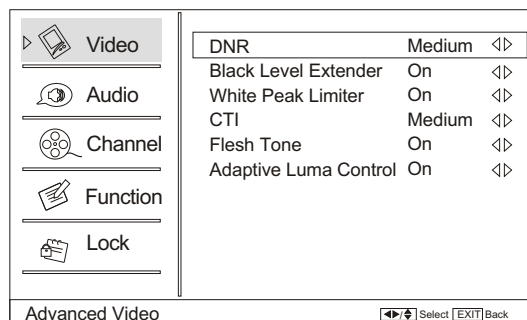

## PC Set

When you select the PC input, this function is used.

### Adjustment for screen Position, Clock, Phase, Setting

Display adjust menu by pressing **INPUT** button then use ▲/▼ button to select the the source of PC item.

■ Auto sync: Automatically adjust display of the picture (Only available in PC source).

■ Position : Adjust the screen position.

■ Phase : Adjust the phase of Pixel clock.

■ Clock : Adjust the clock of input signal.

1. Press **MENU** button and then use ▲/▼ button to select **Video** menu.
2. Press ▶/ENTER button and then use ▲/▼ button to select **PC**.
3. Press ▶/ENTER button and then use ◀/▶ button to adjust the setting.

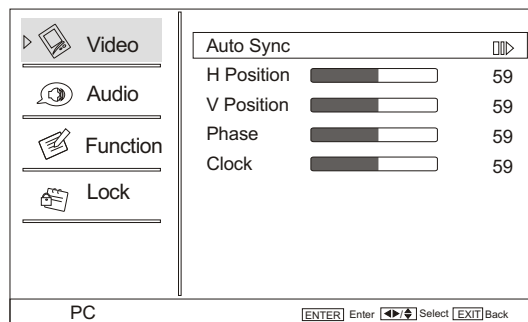
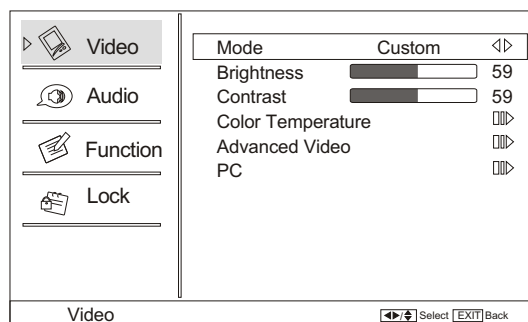

## Audio menu

### How to select audio mode

1. Press **MENU** button and then use **▲/▼** button to select **Audio** menu.
2. Press **▶/ENTER** button and then use **▲/▼** button to select **Mode**.
3. Press **▶/ENTER** button to select the option Off, Concert, Living Room, Hall, Bathroom, Cave, Arena and Church. You can also press **AUDIO** button on the remote control to select the Audio Mode Off, Concert, Living Room, Hall, Bathroom, Cave, Arena and Church.

### How to Customize your own audio status

1. Press **MENU** button and then use **▲/▼** button to select **Audio** menu.
2. Press **▶/ENTER** button and then use **▲/▼** button to select desired items.
3. Press **▶/ENTER** button and then use **◀/▶** button to adjust the setting.

#### ■ Balance

Adjust to emphasize left or right speaker balance.

#### ■ Bass

Adjust to increase or decrease lower-pitched sounds.

#### ■ Treble

Adjust to increase or decrease higher-pitched sounds.

#### ■ SRS TS XT

To turn the simulated surround sound on and off.

#### ■ Mode

To adjust the audio mode: Off, Concert, Living Room, Hall, Bathroom, Cave, Arena and Church.

#### ■ Equalizer

To adjust the equalizer: Off, Rock, Pop, Live, Dance, Techno, Classic and Soft.

#### ■ SPDIF Type

To Adjust the SPDIF output: Off, Dolby Digital and PCM.

#### ■ AVL(Automatic Volume Control)

This will reduce the differences in volume level among broadcasters.

■ **Audio Only** Press **▶/ENTER** button to confirm, the following display will appear on the screen.

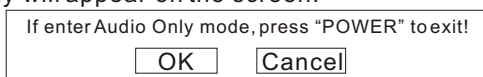

Press **◀** to select **OK**, then press **OK** to confirm. The TV screen will be black and no picture, but the sound is still normal.

You can press **POWER** button to reveal the picture on the screen.

## SAP Broadcasts Setup

This TV can receive MTS stereo programs and SAP (Secondary Audio Program) that accompanies the stereo program; if the station transmits an additional sound signal as well as the original one.

When having selected **SAP** button on the remote control, this TV can only receive the signal when the TV station transmits the proper signals.

Mono sound is automatically received if the broadcast is only in Mono; even though Stereo or SAP has been selected.

Select Mono if you want to listen to mono sound during stereo/SAP broadcasting. Stereo or SAP can be received in a Analog channel.

1. Use **SAP** button to select your desired MTS mode in a analog signal.

Each time you press **SAP** button, Mono, Stereo or SAP appear.

If other languages are available on the digital signal, select them with the **SAP** button.

2. Press **EXIT** button to save and return to TV viewing.

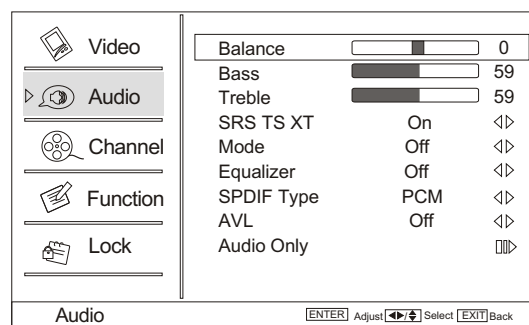

# Function menu

## Menu Language

When you start using your set for the first time, you must select the language which will be used for displaying menus and indications.

1. Press **MENU** button and then use **▲/▼** button to select **Function** menu.
2. Press **▶/ENTER** button and then use **▲/▼** button to select **Language**.
3. Press **◀/▶** button to select language.  
(English, Spanish or French)

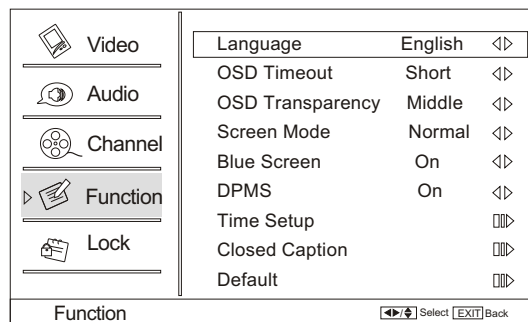

## OSD Timeout

1. Press **MENU** button and then use **▲/▼** button to select **Function** menu.
2. Press **▶/ENTER** button and then use **▲/▼** button to select **OSD Timeout**.
3. Press **◀/▶** button to select **Short, Middle or Long**.  
(Short is for 5 seconds; Middle is for 10 seconds; Long is for 15seconds)

## OSD Transparency

1. Press **MENU** button and then use **▲/▼** button to select the **Function** menu.
2. Press **▶/ENTER** button and then use **▲/▼** button to select **OSD transparency**.
3. Press **◀/▶** button to select **Low ,Middle or High**.

## Screen Mode

Lets you choose the way an analog picture with a 4:3 aspect ratio is displayed on your TV with a 16:9 ratio picture format.

### Note

If a fixed image is displayed on the screen for a long time, the image may become permanently burned on the screen and remain visible.

1. Press **MENU** button and then use **▲/▼** button to select **Function** menu.
2. Press **▶/ENTER** button and then use **▲/▼** button to select **Screen Mode**.
3. Press **◀/▶** button to select **Normal, Zoom, Wide or Cinema**.

### ■ Normal

Choose normal when you want to view the picture with 4:3 mode .

### ■ Zoom

Choose Zoom when you want to view the picture without any alteration. However, the top and bottom portions of the picture will be cropped.

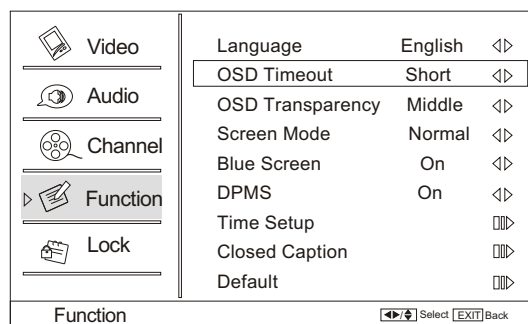

## Function menu

### ■ Wide

Choose wide when you want to adjust the picture horizontally, in a linear proportion to fill the entire screen.

### ■ Cinema

For letterbox pictures, bars may appear on the top and bottom on some programs.

You can also press **ARC** button on the remote control to select the desired picture format: **Normal**, **Zoom**, **Wide** or **Cinema**.

## Blue Screen

1. Press **MENU** button and then use **▲ / ▼** button to select **Function** menu.
2. Press **▶ / ENTER** button and then use **▲ / ▼** button to select **Blue Screen**.
3. Press **◀ / ▶** button to select **On** or **Off**.

## DPMS

PC Power Management. To set On, the set will be in standby mode automatically if no signal in 2 minutes; if signal input, the set will be on again automatically.

Note: DPMS is useful only in VGA source.

## Time zone setting

This function allows you to select your local time zone. Broadcasted time information will correct the clock display for your local time.

1. Press **MENU** button and then use **▲ / ▼** button to select **Function** menu.
2. Press **▶ / ENTER** button and then use **▲ / ▼** button to select **Time Setup**.
3. Press **▶ / ENTER** button and then use **▲ / ▼** button to select **Time Zone**.
4. Press **◀ / ▶** button to select your viewing area time zone: **Eastern**, **Central**, **Mountain**, **Pacific**, **Alaska** or **Hawaii**.

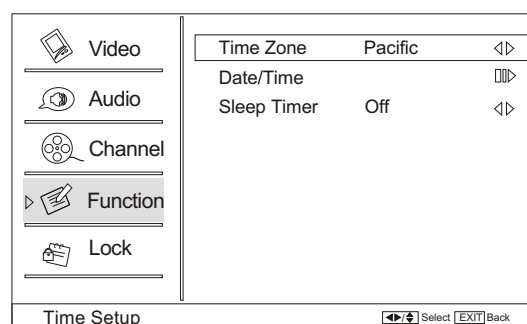

## Date /Time setting

Setting the clock is necessary in order to use the various timer features of the TV. Also, you can check the time while watching the TV.

1. Press **MENU** button and then use **▲ / ▼** button to select **Function** menu.
2. Press **▶ / ENTER** button and then use **▲ / ▼** button to select **Time Setup**.
3. Press **▶** or **ENTER** button and then use **▲ / ▼** button to select **Date/Time**.
4. Press **▶ / ENTER** button and then use **◀ / ▶** button to select **On** or **Off**.

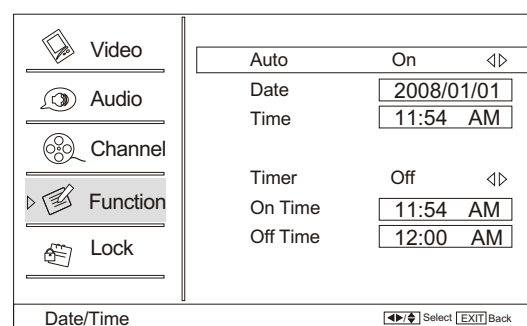

# Function menu

## Sleep Timer setting

The sleep timer automatically shuts off the TV after a preset time (from 5 to 240 minutes).

1. Press **MENU** button and then use ▲ / ▼ button to select **Function** menu.
2. Press ► / **ENTER** button and then use ▲ / ▼ button to select **Time Setup**
3. Press ► / **ENTER** button and then use ▲ / ▼ button to select **Sleep Timer**.
4. Press ◀ / ▶ button to select the number of minutes. Select **Off, 5Min, 10Min, 15Min, 30Min, 45Min, 60Min, 90Min, 120Min, 180Min** or **240Min**.  
The time begins to count down from the number of minutes selected.
5. To cancel the set sleep timer: Press ► button to select **Off**.

You can also press **SLEEP** button to select quickly the sleep timer.

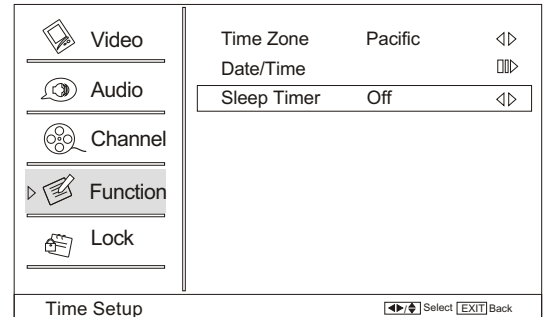

## DTV Caption Style (In DTV mode)

This allows you to modify how digital captions are displayed on your TV. Select from the following options to change the visual characteristics of your TV's digital captioning.

Customize the DTV/CADTV captions that appear on your screen.

1. Press **MENU** button and then use ▲ / ▼ button to select **Function** menu.
2. Press ► / **ENTER** button and then use ▲ / ▼ button to select **Closed Caption**.
3. Press ► / **ENTER** button and then use ▲ / ▼ button to select **DTV Caption Style**.
4. Press ► / **ENTER** button and then use ▲ / ▼ button to select the Style, Size, etc., press ◀ / ▶ button to customize to your preference.

### ■ Style

Select this option to select the font style of caption display according to your own preference.

Press ◀ / ▶ button to select **Default** or **Custom**.

### ■ Size

Select this option to select the size of caption display according to your own preference.

Press ◀ / ▶ button to select **Small**, **Normal** or **Large**.

### ■ Text color

Select this option to select the text color or the opacity of the text box of caption display according to your own preference.

Select a color and one of the opacity options.

### ■ Text Opacity

Specify the opacity for the text color.

### ■ BG Color

Select a background color.

### ■ BG Opacity

Select the opacity for the background color.

### ■ Window Color

Select a window color.

### ■ Window Opacity

Select the opacity for the window color.

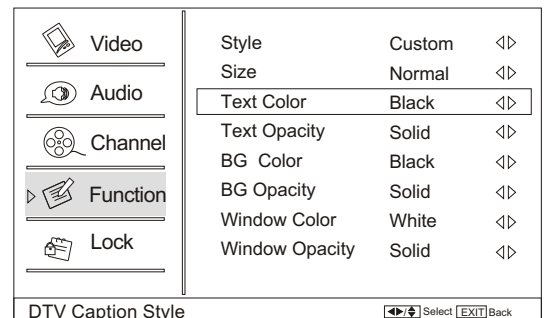
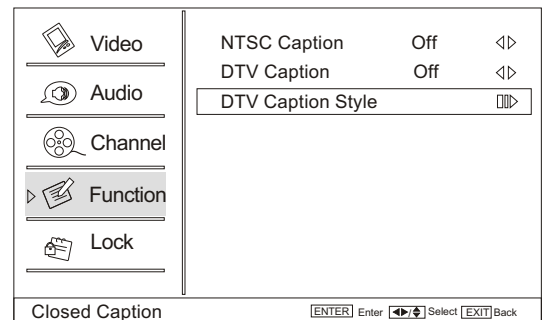
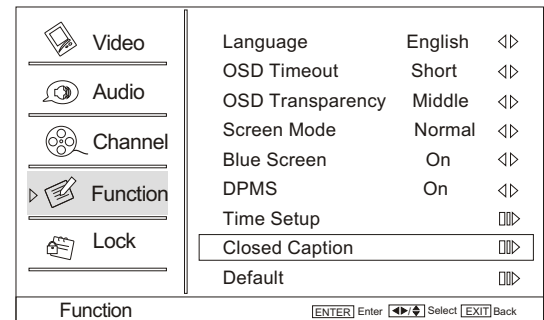



# Lock Menu

Parental Control can be used to block specific channels, ratings and other viewing sources.

The parental control function is used to block program viewing based on the ratings sent by the broadcasting station. The default setting is to allow all programs to be viewed. Viewing can be blocked by choosing the type of the program and the categories.

## Parental Control rating and categories

Rating guidelines are provided by broadcasting stations. Most television programs and television movies can be blocked by TV Rating or Individual Categories. Movies that have been shown at the theaters or direct-to-video movies use the Movie Rating System (MPAA) only.

### Ratings for Television programs :

#### Parental Guide

- TV-Y (All children)
- TV-Y7 (Children 7 years older)
- TV-G (General audience)
- TV-PG (Parental guidance suggested)
- TV-14 (Parents strongly cautioned)
- TV-MA (Mature audience only)

### Ratings for Movies previously shown in theaters:

#### MPAA Rating :

- G (General audience)
- PG (Parental guidance suggested)
- PG-13 (Parents strongly cautioned)
- R (Restricted)
- NC-17 (No one 17 and under admitted)
- X (Adult only)

If you set PG-13: G and PG movies will be available, PG-13, R, NC-17 and X will be blocked.

### CA Eng Rating

- C Children
- C8+ Children eight years and older
- G General Programming, suitable for all audiences
- PG Parental Guidance
- 14+ Viewers 14 years and older
- 18+ Adult Programming

### CA Fren Rating

- G General
- 8 ans+ Not recommended for young children
- 13 ans+ Programming may not be suitable for children under the age of 13
- 16 ans+ Programming is not suitable for children under the age of 16
- 18 ans+ Programming restricted to adults

### TV Rating :

- A (Age) (applies to TV-Y, TV-Y7, TV-G, TV-PG, TV-14, TV-MA)
- D (Dialogue - sexual dialogue) (applies to TV-PG, TV-14)
- L (Language - adult language) (applies to TV-PG, TV-14, TV-MA)
- S (Sex - sexual situations) (applies to TV-PG, TV-14, TV-MA)
- V (Violence) (applies to TV-PG, TV-14, TV-MA)
- FV (Fantasy Violence) (applies to TV-Y7)

# Lock Menu

## Lock setup

Set up blocking schemes to block specific channels, ratings, and external viewing sources.

A password is required to gain access to this menu.

1. Press **MENU** button and then use **▲ / ▼** button to select **Lock** menu. Then, press **▶** button.

The TV is set up with the initial password “0-0-0-0” and security default password is 9-4-4-3.

2. Use **▲ / ▼** button to select the desired items, and press **▶** or **ENTER** button to enter the next menu. Once the option is selected, change the settings to your preference.

### Password

Change the password by inputting a new password twice.

### Channel Block

1. Press **MENU** button and then use **▲ / ▼** button to select **Lock** menu.
2. Press **▶ / ENTER** button and then use **▲ / ▼** button to select **Channel Block**.
3. Press **▲ / ▼** button to select the item, Press **OK** button to set.

### Parental Lock

1. Press **▲ / ▼** button to select **Parental Lock** item.
2. Press **◀ / ▶** button to select **On** or **Off**.

#### Note

If the Parental Lock is setting as Off, the change of the Parental Guide, MPAA Rating, CA Eng Rating and CA Fren Rating will be no useful.

### Parental Guide

#### Note

The Parental control will automatically block certain categories that are “more restrictive”. For example, if you block “TV-Y” category, then all the categories in the “young adult” group will be blocked (TV-Y, TV-Y7, TV-G, TV-PG, TV-14 and TV-MA).

The sub-ratings (D, L, S, V, FV) work together similarly.

#### How to set the D, L, S, V and FV sub-ratings.

First, press **▲ / ▼** button select one of these Ratings: TV-Y, TV-Y7, TV-G, TV-PG, TV-14, or TV-MA, and press **◀ / ▶** button.

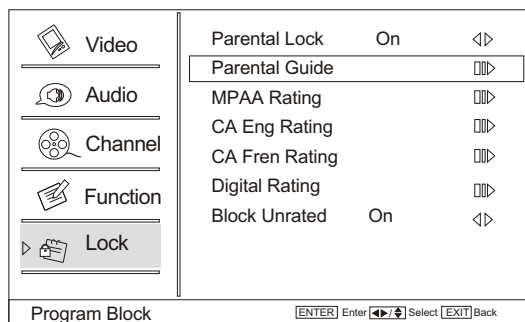
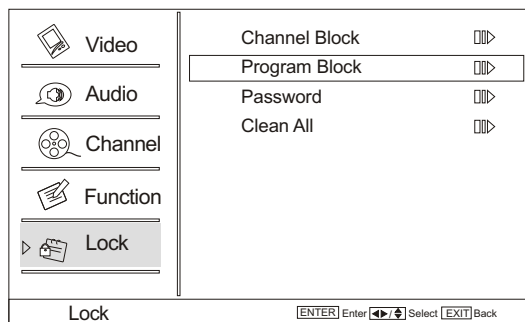
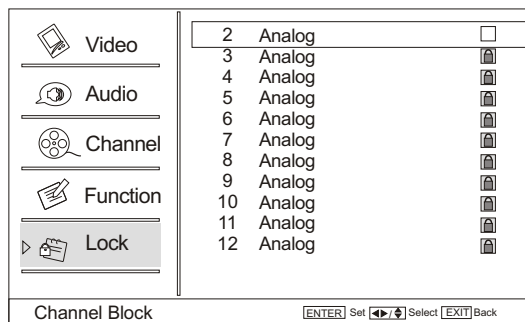
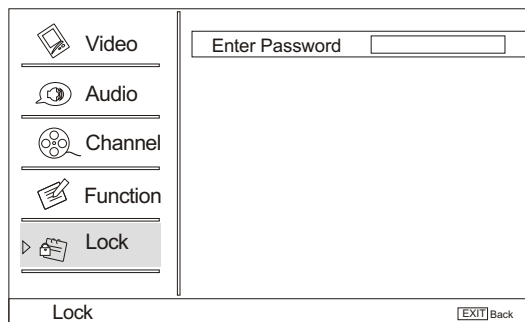

# Lock Menu

## Lock setup

A symbol “” will be displayed for each sub-rating. While “” is selected, press **ENTER** button to go to a sub rating. To select a different Rating, press **▲/▼** buttons and then repeat the process.

### Note

The V-chip will automatically block certain categories that are “More restrictive”. For example, if you block “” sub-rating in TV-PG, then the “” sub-ratings in TV-14 and TV-MA will automatically be blocked.

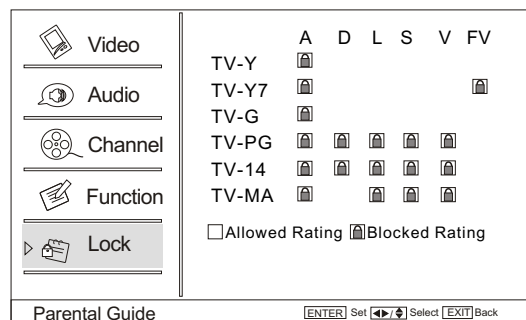

### MPAA Rating

Blocks movies according to the movie ratings limits specified, so children cannot view certain movies. You can set the ratings limit by blocking out all the movies with the ratings above a specified level. Keep in mind that the movie ratings limit only applies to movies shown on TV, not TV programs, such as soap operas.

1. Press **▲/▼** button to select **MPAA Rating** item.
2. Press **▶/ENTER** button and then use **▲/▼** button to select the rating.
3. Press **ENTER** button to set block or unblock.

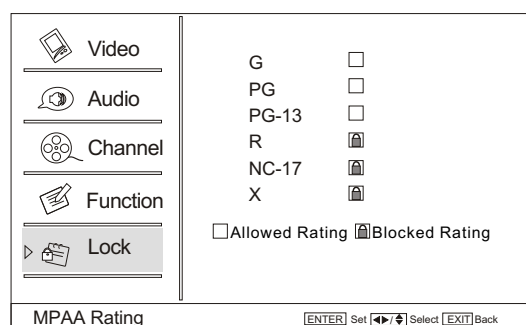

### CA Eng Rating

#### Canadian English Language Rating

1. Press **▲/▼** button to select **CA Eng Rating** item.
2. Press **▶/ENTER** button and then use **▲/▼** button to select the rating.
3. Press **ENTER** button to confirm.

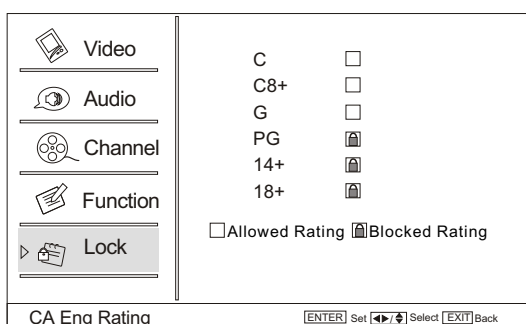

### CA Fren Rating

#### Canadian French Language Rating

1. Press **▲/▼** button to select **CA Fren Rating** item.
2. Press **▶/ENTER** button and then use **▲/▼** button to select the rating.
3. Press **ENTER** button to confirm.

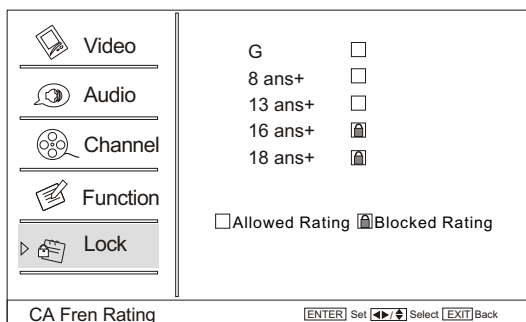

# Other Functions

## Brief Info

Brief Info shows the present screen information.  
 Press **DISPLAY** button to show the Brief Info on the screen.  
 Press **DISPLAY** button or **EXIT** button to exit.

## Function:

- Show the present screen information.
- Press **DISPLAY** button or **EXIT** button to exit.

- A: Video resolution
- B: Program name
- C: Program rating categories
- D: program showtime
- E: Program title
- F: Channel Lable
- G: Tuner mode
- H: Program details

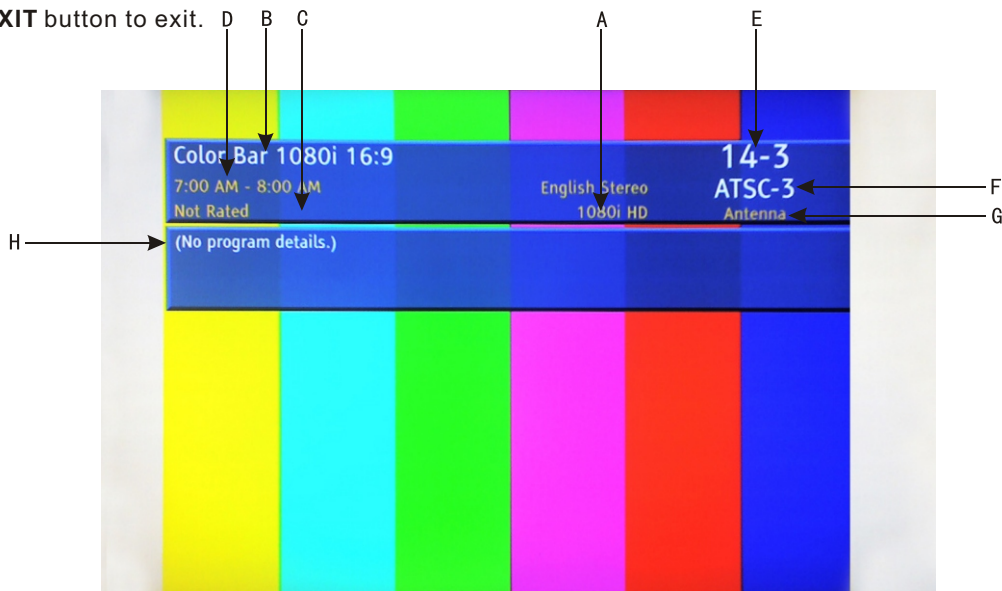

## Using the Guide

The guide allows you to select the channels from a channel list.  
 The guide allows provides information about the current program being shown on each channel(if information is available from the station).

### Note

Program information in the guide is provided by the broadcasters. As a result, it may sometimes include only the channel number, without a program title or description.

- A: Program title
- B: program options
- C: program showtime
- D: Program details
- E: Program rating categories

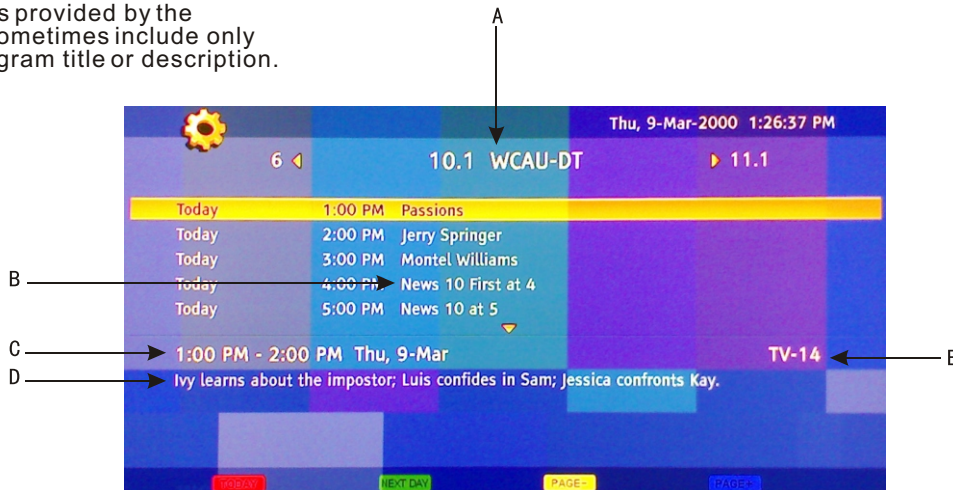

## Other Functions

### Quick program view

Press to jumpback and forth between two channels. The TV alternates between the current channel and the last channel that was selected.

1. Suppose the channel number you used just now is 8 and the channel number you are using is 18 (as shown in the figure).
2. If you want to return to the last watched program channel 8, you can simply press **RECALL** button.
3. If you want to return to channel 18, press the button again.

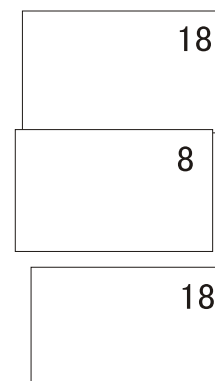

### CC (Closed Caption Display)

#### Closed Captions

Closed captioning is a process which converts the audio portion of a television program into written words which then appear as subtitles on the television screen. Closed captions allow viewers to read the dialogue and narration of television programs.

#### Using Closed Captions

Captions are the subtitles of the dialogue and narration of television programs. For prerecorded programs, program dialogue can be arranged into captions in advance. It's possible to caption a live program by using a process called real-time captioning, which creates captions instantly. Real-time captioning is normally done by professional reporters using a machine shorthand system and computer for translation into English. Captioning is an effective system for the hearing-impaired, and it can also aid in teaching language skills.

In ATV mode CCD function allows you to configure the way you choose to view the digital captioning (Off, CC1, CC2, CC3, CC4, Text1, Text2, Text3 or Text4).

#### ■ CAPTION

The term for the words that scroll across the bottom of the TV screen; usually the audio portion of the program provided for the hearing impaired.

#### ■ TEXT

The term for the words that appear in a large black frame and almost cover the entire screen; usually messages provided by the broadcaster.

In DTV mode allows you to configure the way you choose to view the digital captioning (Off, service1, service2, service3, service4, service5 or service6).

Select one of the digital service channels made available by the caption provider.

There are 6 standard services. Service 1 is designated as the Primary Caption Service. This service contains the verbatim, or near-verbatim captions for the primary language being spoken in the accompanying program audio. Service 2 is designated as the Secondary Language Service. This service contains captions in a secondary language which are translations of the captions in the primary Caption Service. The other service subchannels are not pre-assigned. It is up to the discretion of the individual caption provider to utilize the remaining service channels.

#### Note

The captions do not always use correct spelling and grammar. Not all TV programs and product commercials are made for broadcast with Closed Caption information included. Refer to your area's TV program listings for the TV channels and times of Closed Caption shows. The captioned programs are usually noted in the TV listings with service marks such as "CC".

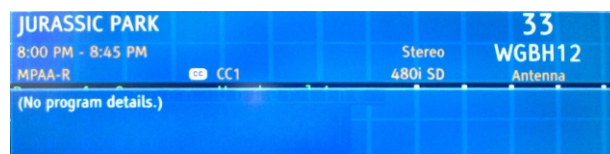

# USB Input

1. Supporting media and file format: Digital pictures (.JPG) and digital music (.MP3) files

Due to differences in the file code and file mode, It is possible that some files cannot be read.

2. Before starting operation, verify USB storage device is of FAT32 and FAT file system format. At present, this television does not support NTFS and the file systems of other format.

3. External card reader supports most digital cards available in the market. Readable digital cards are classified according to the property of card readers and can be connected to mobile hard disks (working voltage 5.0V, working current not over 500mA).

4. The television operation may be halted due to excessive rate of information code errors. In such case, restart the system. Please note - there are many nonstandard USB mobile devices in the market. If a nonstandard device is used then an identification problem may occur.

## To play picture

1. Press USB button on the remote to enter stream media system.

The system start up takes about 3 second. Then insert the USB drive in the USB input.

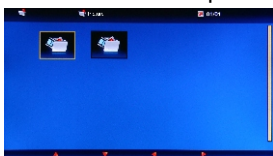

2. Press ◀/▶ button to select Picture option. Press ENTER to enter.

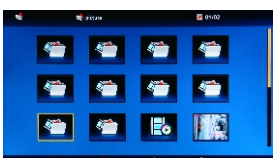

3. Press ▲/▼/◀/▶ button to select desired picture, and then press ENTER button to enter the play interface.



- 1. Play mode: None/Dissolve/Wipe left/Wipe right/Wipe up/Wipe down/Box in/Box out
- 2. Play time: Short/Medium/Long; 3. File name
- 4. Pause/Play
- 5. Duration/Rotate
- 6. Effect
- 7. Information

4. Press the button on the remote control to select the item, press ENTER button to confirm.

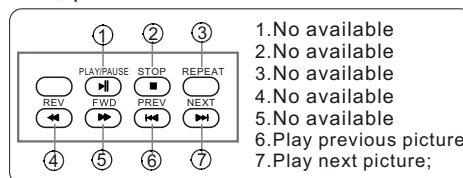

- 1. No available
- 2. No available
- 3. No available
- 4. No available
- 5. No available
- 6. Play previous picture;
- 7. Play next picture;

5. Press EXIT button to return to the previous menu. Press USB button to exit the USB mode.

Note: you may play the pictures among selected.

## To play music

1. Press ◀/▶ button to select Music option. Press ENTER to enter.

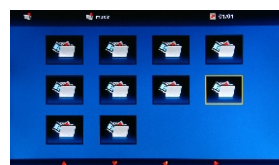

2. Press ▲/▼/◀/▶ button to select desired music, and then press ENTER button to enter the play interface.

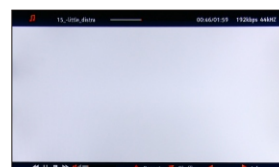

3. Press the button on the remote control to select the adjusted item, press ENTER button to confirm.

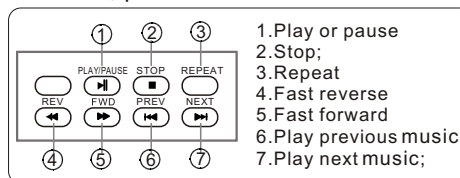

- 1. Play or pause
- 2. Stop;
- 3. Repeat
- 4. Fast reverse
- 5. Fast forward
- 6. Play previous music;
- 7. Play next music;

4. Press EXIT button to return to the previous menu. Press USB button to exit the USB mode.

Note: You may play the music among selected.

# USB Input

## To play pictures and music together

Insert USB drive with music and picture files into the USB input, select the Music folder and choose the MP3 files to be played. Then select the pictures to be played. Please note as some files must be read while music is being played, the speed of picture operation response might be affected.

1. Press ◀/▶ button to select Music folder.  
Press ENTER to enter.

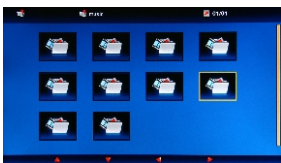

2. Press ▲/▼/◀/▶ button to select the desired music, and then press ENTER button to enter to play.

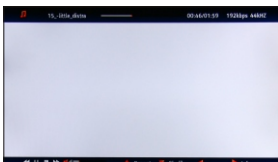

3. Press EXIT button to turn to the main menu. And then press ◀/▶ button to select Picture option.  
Press ENTER to enter.

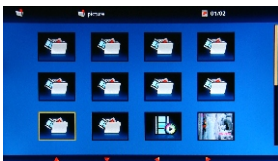

4. Press ▲/▼/◀/▶ button to select desired picture, and then press ENTER button to enter the play interface.

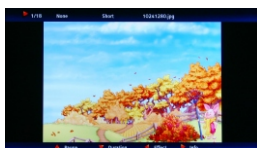

5. Press USB button to exit USB mode.

**Note:** Do not remove USB device from the TV until you have exited the USB mode otherwise you may damage the USB device.

# Universal Remote Control

## Setting Up Your Remote Control

After it has been set up properly, your remote control can operate in six different modes: TV, DVD, VCR, SETBOX, CABLE or AUDIO.

### Note

The remote control might not be compatible with all DVD Players, VCRs and Cable boxes.

## Control Operation

1. Program the Controller to work with your device.
2. Changing device mode by pressing the TV, DVD, STB, CABLE, VCR, AUD key. When device is set, related device LED will be on for 1 second and then be off.
3. Aim the remote at the device.
4. Use the other Controller buttons to operate the device. Device LED will blink if user presses any key (if the key has data in current mode.). If the key has no data, then LED will not blink.
5. Default init status: TV/Legend codeset.

### Manually Programming the Control

Check the code no. from the code list.

1. Choose the device you want to program.
2. While Press and holding ENTER key, press INPUT key, and device LED will be ON. Keep the status for about 3 seconds and the LED will blink, indicating that the Controller is ready for programming, then release both keys.
3. Led will blink once when you enter a digit key, indicating the digit key is programmed. If 3 digits are programmed successfully, device LED will be ON for about 3 seconds and then blink twice per second. Then User now can:
  - a) Try to operate the device by using power key.
  - B) If operation can be done, press ENTER key to save current 3-digits code brand to EEPROM and exiting manually programming mode.
  - C) Return to beginning of step 3. Reprogram the control.
4. If user's input is incorrect, LED will blink 6 times in 3 seconds (2HZ). And then keep 2HZ blink, user now can return to step 3 and re-program the device. Within 30 seconds, user should enter the 3-digit brand code corresponding to your device. If time out or any key other than Power and digits is pressed, LED will be off and manually programming process is exit.

### Manually scan mode

With manually scan programming, the Controller tests all the codes available in the codeset database and assign the correct one for the selected device. Although this method is more time consuming, it saves you the trouble of looking up the brand codes necessary for manual programming.

To manually-scan program the Controller:

1. Manually turn OFF the device for manually scan mode. (TV, VCR, DVD, STB, cable box or audio equipment).
2. Choose the device you want to program.
3. While Press and holding ENTER key, press INPUT key, and device LED will be ON. Keep the status for about 3 seconds and the LED will blink, indicating that the Control is ready for programming, then release both keys.
4. Press and release the CH+/CH- key. it will emit the next or the previous POWER key code. The LED blinks with 10HZ freq, indicating that the Remote is in manually scan mode.
5. Press CH+/CH- key repeatedly until the device switches ON (CH+ key conducts a upward search while the CH- key conducts a downward search in the code set database). When the device turns ON, press and release the ENTER key to program the Controller with the new code, saving the code to EEPROM and exit.
6. After saving the new code, press POWER key. If the device responds, no further programming is required. If the device does not respond, repeat step 3 through 5. And searching will start from current code set.

To exit without programming, press any key or no key was pressed in 30 second, manually scan mode will be automatically exit. The code cannot be saved to EEPROM.

After searching the entire data base, this mode will be automatically exited and led will blink for 3 times in 1.5 seconds. The code can not be saved to EEPROM.

### Automatic Scan Programming the Controller

To automatic scan program the Controller:

1. Manually turn OFF the device you wish to power scan. (TV, VCR, DVD, STB, cable box or audio equipment).
2. choose the device you wish to program.
3. While Press and holding ENTER key, press the INPUT key and device LED will be ON. Keep the status for about 3 seconds and the LED will blink, indicating that the Controller is ready for programming, then release both keys.
4. Press and release the Mute key to enter automatic scan mode. And the remote will automatically sending codes to the device per 2 seconds.
5. When the device turns ON, press ENTER key to program the Controller with the new code, saving it to EEPROM and exit.
6. Press POWER key. If the device responds, no further programming is required. If the device does not respond repeat steps 1 through 5.
7. After searching the entire data base, this mode will be automatically exited and led will blink for 3 times. The codeset is not saved to EEPROM.

In automatic scan mode, press any key other than ENTER key will exit without programming,.



# Universal Remote Control

## Display mode

1. choose the device you wish to program.
2. To enter display mode, while press and holding ENTER key, press the INPUT key and device LED will be ON, keep the status for about 3 seconds and the LED will blink, indicating that the Controller is ready for programming, then release both keys.
3. Sequence press 9, 8, 0 to enter display mode.
4. Press digit 1 key to get the first digit of current codeset. For example, if the first digit of codeset is 1, so then led will blink once and remains OFF. Digit "0" in codeset will not be displayed. Blink Freq is 1HZ.
5. Press digit 2 key to get the second digit of current codeset. For example, if the second digit of codeset is 3, so then led will blink three times and remains OFF. Blink Freq is 1 HZ.
6. Press digit 3 key to get the third digit of current codeset. Blink Freq is 1 HZ.
7. Only digit 1, 2, 3 are valid in this mode. And the sequence is not fixed.

Controller will not send out data in this mode if user presses any keys other than digit 1, 2, 3, or no key was pressed in 30 seconds, display mode is ended.

## Punch-Through Features

The Controller provides two punch-through features that allow users to control TV volume and DVD or VCR operation while the Controller is in another device mode control certain features of another device.

### Volume Punch-Through

The TV Volume/Mute punch-through feature allows you to control the volume and mute function of your TV while the Controller is in another device mode. The feature is applicable for all devices and brands that do not use the volume control buttons for other purposes.

### Transport Key Punch-Through

The DVD or VCR transport key punch through feature lets you control the PLAY, STOP, PAUSE, REWIND, FF and RECORD functions of your DVD or VCR while the Control operates in other modes. The feature is applicable for all devices and brands that do not use the transport keys for other purposes.

## Fast Programming default TV codeset

Press and holding the ENTER key and then press POWER key for 3 seconds, the LED will blink 3 times and turn off, default Legend codeset (001) will be programmed to the control.

# Universal Remote Control

## Remote Control Codes

### TV

NO.	Brand	Code
1	Legend	001
2	Abex	077
3	Acer	267
4	Addison	333
5	Admiral	057 078 334 338
6	Advent	324
7	Adventura	079
8	Aiko	066 333
9	Aiwa	165
10	Akai	038 058 258 271 279 331 350
11	Albatron	321 325
12	Alleron	068
13	America Action	335
14	Ampro	323
15	Amtron	067
16	Anam	335
17	Anam National	059 067
18	AOC	060 061 062 222 331 349 350 353
19	Apex	092 135 151 195 339
20	Archos	308
21	Astar	259
22	Audiovox	067 189 191 207 256 333 335 337
23	Aventura	053
24	Axion	280
25	Bang & Olufsen	345 346
26	Baur	058
27	Belcor	060 349
28	Bell & Howell	057
29	Benq	245 246 284 329
30	Bradford	067 335
31	Brilliant	342
32	Brockwood	060 349
33	Broksonic	197 335 338
34	byd:sign	310
35	Candle	060 062 063 079 331 350
36	Carnivale	331 350
37	Carver	055 320
38	CCE	239 351
39	Celebrity	058
40	Celera	339
41	Centurion	064
42	Changhong	339
43	Ching Tai	333
44	Chun Yun	333 335 361 374
45	Chung Hsin	335 364
46	Citizen	060 062 063 066 067 074 076 331 333 350 352 354 380
47	Clarion	335
48	Coby	210
49	Colortyme	060 062
50	Colt	377
51	Commercial Solutions	332
52	Concerto	060 062
53	Contec	335
54	Contec/Cony	065 067
55	Craig	067 335
56	Crosley	055 293 320
57	Crown	067 071 335 352
58	CTX	235
59	Curtis Mathes	038 055 056 060 062 074 076 088 320 331 332 334 337 340 350 352 354
60	CXC	067 335
61	Cytron	238 278
62	Daewoo	060 061 062 066 076 093 117 125 152 333 337 349 352 380
63	Daytron	060 062 076 349
64	Dell	251 285 304
65	Denon	340
66	DiamondVision	311 317 319
67	Dimensia	056 088
68	Disney	132
69	Dumont	031 060 330 349
70	Durabrand	053 097 137 341 335 338
71	Dwin	322 334
72	Electroband	058
73	Electrograph	243
74	Electrohome	058 059 060 062
75	Element	228
76	Emerson	053 060 062 065 067 068 076 093 137 266 292 335 338 349 352 380
77	Emprex	314
78	Envision	060 062 222 331 350

NO.	Brand	Code
79	Epson	225
80	Erres	347
81	ESA	053
82	Ether	362
83	Firststar	372
84	Fujitsu	068 216
85	Funai	053 067 068 335
86	Furi	368
87	Futuretech	067 335
88	Gateway	243 274 341 360
89	GE	027 056 059 060 062 069 070 085 088 107 116 332 337 378
90	GFM	051 305
91	Gibraltar	031 060 330 331 349 350
92	Go Video	328
93	Goldstar	060 061 062 065 076 077 331 349 350 379
94	Gradiente	242
95	Grundig	351
96	Grunpy	067 068 335
97	Haier	001 002 003 004 005 006 007 008 009 010 240 241 297 307 355
98	Hankook	335 362 371
99	Harman/Kardon	055
100	Harvard	067 335
101	Havermy	334
102	Hello Kitty	337
103	Hewlett Packard	175 204 219
104	Hisense	250 370 375
105	Hitachi	032 060 062 065 126 127 134 149 150 186 200 340
106	HP	204 219
107	Hyundai	327
108	Hallmark	060 062
109	IMA	067
110	Infinity	055 071 320
111	InFocus	275
112	Initial	277
113	Innova	351
114	Insignia	097 237 298 299 300 306 313
115	Inteq	330
116	Ilo	174 254 266 312
117	Janeil	079
118	JBL	055 071 320
119	JC Penney	056 060 061 062 063 069 070 074 076 077 088
120	JCB	058
121	Jean	333 363 370 372
122	Jensen	060 062 236
123	Jinjing	365 368 370
124	JVC	047 048 049 065 070 114 154 172 199 201
125	Kawasho	058 060 062
126	Kaypani	353
127	KEC	335
128	Kenwood	060 062 331 349 350
129	Kioto	055
130	KLH	339
131	Kloss Novabeam	067 079
132	Kolin	335 369
133	KTV	067 076 331 335 350 352
134	LG	030 060 061 182 224 257 302 321 350
135	Loewe	071
136	Logik	057
137	Luxman	060 062
138	LXI	055 056 062 071 088 151 320 332
139	M & S	055
140	Magnasonic	380
	Magnavox	052 055 060 062 063 071 090 105 108 110 163 174 176 218 320
141		331 350
142	Magnin	378
143	Majestic	057
144	Marantz	055 060 062 071 231 272 320 331 350 351
145	Matsushita	336
146	Maxent	243 252 301
147	Mediator	374
148	Megapower	321
149	Megatron	062 340
150	Memorex	057 061 062 137 181 338 376 379
151	MGA	060 061 062 331 349 350 378
152	Midland	031 070 076 077 330 332 352
153	Mintek	174
154	Minutz	069
155	Mitsubishi	060 061 062 119 159 170 334 349

# Universal Remote Control

## Remote Control Codes

NO.	Brand	Code	NO.	Brand	Code
156	Monivision	321 325	227	SKY	351
157	Montgomery Ward	057	228	Skygiant	335
158	Motorola	059 078 334	229	Sony	011 012 013 014 015 016 058 087 094 101 102 118 124 128 136
159	MTC	060 061 062 074 331 349 350 354			148 153 184 206 226 287 288
160	Multitech	067 335	230	Soundesign	060 062 063 067 068 335
161	Multivision	072	231	Sowa	366 370
162	NAD	062 151 351	232	Squareview	053 080
163	NEC	059 060 061 062 234 268 331 349 350	233	SSS	060 067 335 349
164	Netsat	351	234	Starlite	067 335
165	NET-TV	243 247	235	Studio Experience	325
166	Newave	333 367 371	236	Superscan	052 260 334 356
167	Nikko	062 066 331 333 350	237	Supre-Macy	079
168	Norcent	222	238	Supreme	058
169	Noshi	348	239	SVL	230 355
170	NTC	066 333	240	Sylvania	046 050 051 052 053 054 055 060 062 063 071 137 141 161 289
171	Olevia	138 192 221 357 358			320 331 350
172	Onwa	067 335	241	Symphonic	053 067 080 141 335
173	Oppo	282	242	Synco	333 337 361 366 367 371
174	Optimus	336 376	243	Syntax	138 192 344 357 358
175	Optoma	276	244	Syntax-Brilliant	192 244
176	Optonica	073 078 334	245	Tacico	333 371
177	Orion	097 338	246	Tandy	078 334
178	Otto Versand	058	247	Tatung	059 253 273 341 360 363 366 370
	Panasonic	021 022 023 024 025 026 059 070 071 086 103 122 144 147 155 168 183	248	Technics	070 336
179		185 336 376	249	Techview	326
180	Penney	151 331 332 348 349 350 352 354 378 379	250	Techwood	060 062 070
181	Philco	055 059 060 061 062 063 065 071 181 320 331 349 350	251	Teco	363 367 371
	Philips	040 041 042 043 044 045 046 055 059 060 063 065 071 089 090 091 096	252	Teknika	055 057 060 061 062 063 065 066 067 068 074 076 320 333 335
182		160 162 164 169 174 177 179 190 208 291 320 347 351			349 352 354
183	Philips Magnavox	042 045 089 090 096	253	Telecaption	075
184	Phonola	347	254	Telefunken	038
185	Pilot	060 076 331 349 350 352	255	Thomson	088
186	Pioneer	060 062 156 157 205 212	256	TMK	060 062
187	Plasmsync	269	257	TNCi	330
188	Polaroid	211 217 220 228 315 339		Toshiba	017 018 019 020 074 075 099 100 104 106 109 111 113 115 120
189	Portland	060 061 062 066 076 333 349 352	258		123 146 151 173 227 354
190	Price Club	074	259	Totevision	076 352
191	Prima	281 324	260	Trutech	248
192	Princeton	321	261	Tuntex	333 362
193	Prism	070	262	TVS	338
194	Proscan	027 056 088 332	263	Universal	069
195	Proton	060 062 065 353	264	Vector Research	331 350
196	Protron	196 262	265	Victor	065
197	Proview	263 343	266	Vidikron	055 320
198	Pulsar	031 060 330 349	267	Vidtech	060 061 062 349
199	Pye	347	268	Viewsonic	133 214 218 223 233 243 316 356
200	Quasar	022 059 070 336 376	269	Viking	079
201	Quelle	058	270	Viore	254
202	Radio Shack/Realistic	056 060 062 065 067 073 076 077	271	Visco	309
203	Radiola	347	272	Vizio	133 257 261 296 318 341 356 359 360
204	Radio Shack	088 331 332 335 349 350 352	273	Wards	055 056 057 060 061 062 068 069 071 073 088 320 331 349 350
205	RCA	027 028 029 056 059 060 061 062 082 088 095 098 332 348 349 354 378	274	Waycon	151
206	Realistic	088 331 335 349 350 352	275	Westinghouse	133 187 188 195 215 290 303 337
207	Runco	031 330 331 350	276	White Westinghouse	093 338
208	Sampo	060 062 076 077 243 283 331 350 352 353	277	Yamaha	060 061 062 331 349 350
	Samsung	037 038 039 060 061 062 065 074 076 077 129 130 140 143 158 166	278	Yapshe	373
209		178 193 194 209 213 229 232 286 294 295 331 349 350 351 354	279	Zenith	030 031 032 057 060 081 084 093 121 330 333 338
210	Samsux	352			
211	Sansui	097 338			
212	Sanyo	060 249 270 378			
213	SBR	347			
214	Sceptre	264			
215	Scimitsu	349			
216	Scotch	062			
217	Scott	060 062 065 067 068 255 335 349			
218	Sears	053 055 056 060 062 068 080 088 151 244 320 332 379			
219	SEI	058			
	Sharp	033 034 035 036 060 062 065 073 076 078 083 112 131 139 142 145 167			
220		171 180 198 202 203 334 352			
221	Shen Ying	333			
222	Sheng Chia	334 367			
223	Shogun	060 349			
224	Signature	057			
225	Simpson	063			
226	Sinudyne	058			

# Universal Remote Control

## Remote Control Codes

### DVD

NO.	Brand	Code	NO.	Brand	Code
1	Accele Vision	250	83	Lenoxx	333 353
2	Accurian	355	84	Lexicon	357
3	Advent	330	85	LG	102 151 165 185 189 201 211 242 256 283 345 349
4	Aiwa	307	86	Liquid Video	334
5	Akai	280 323 361	87	Liteon	158 219 355 384
6	Alco	328	88	Loewe	356 365
7	Allegro	349	89	Magnavox	068 071 124 156 179 213 298 324 336 339 354
8	Alpine	257	90	Marantz	245 301 302 339
9	Amphion MediaWorks	258	91	Memorex	100 133 323
10	AMW	258	92	Microsoft	338
11	Apex	025 026 027 028 078 117 172 192 342 343	93	Mintek	213 278 343
12	Apple	319	94	Mitsubishi	106 177 190 337
13	Argo	351	95	NAD	264
14	Aspire	332	96	Nakamichi	310
15	Astar	252	97	Nesa	343
16	Audiovox	164 167 223 328	98	Next Base	363
17	Axon	281	99	Nexxtech	271
18	Bang & Olufsen	344	100	Norcent	129 246
19	Blaupunkt	249 343	101	Onkyo	145 188 197 206 207 326 336
20	Blue Parade	340	102	Oppo	273 284
21	BOSE	062 079	103	Oritron	327 334
22	BOSS	251	104	Panasonic	017 018 019 020 021 022 023 024 051 059 067 070 072 073 077 080 083 091 099 135 138 160 181 183 184 199 205 233 234 235 325 336 387 388
23	Boston Acoustics	381	105	Philco	328
24	Broksonic	123 323	106	Philips	007 041 042 071 098 137 144 152 157 168 174 176 178 208 213 336 339 357 385
25	California Audio Labs	325	107	Pioneer	043 044 045 046 047 058 110 150 200 229 247 340 390
26	CambridgeSoundWorks	290	108	Polaroid	028 241 277
27	Changhong	326 375	109	Polk Audio	339
28	CineVision	196 349 350	110	Portland	361
29	Clarion	262	111	Presidian	385
30	Classic	236	112	Prima	282 383
31	Coby	082 129 143 237 331	113	Princeton	358
32	Curtis	129	114	Proceed	342
33	Curtis Mathes	352	115	Proscan	069 338
34	CyberHome	029 048 351 368 373 374 377	116	Pye	276
35	Cytron	279	117	Qwestar	327
36	Daewoo	113 349 361	118	RCA	039 040 069 090 166 191 328 338 340 343
37	Denon	070 182 198 209 299 300 325	119	Regent	333
38	Desay	268	120	Rio	349
39	DiamondVision	320 321 322	121	Rotel	341
40	Disney	100 132	122	Rowa	329
41	Dual	312	123	Sampo	119 265 370 372
42	Durabrand	353	124	Samsung	012 013 014 015 016 054 064 066 074 075 085 104 105 108 111 121 125 134 154 193 210 226 325 389
43	DVD2000	337	125	Sansui	228 275 323
44	Eclipse	227	126	Sanyo	287 323 346
45	Emerson	063 248 324 345 385	127	Sensory Science	384
46	Enterprise	345	128	Sharp	093 119 187 202 220 291 295 296 297
47	ESA	259 354	129	Sharper Image	368
48	Fisher	305 346	130	Sherwood	292 361
49	Funai	354 385	131	Shinco	260
50	Gateway	376 378 384	132	Shinsonic	213 335
51	GE	101 195 338 343	133	Sigma Designs	358
52	GFM	204	134	Sonic Blue	349
53	Go Video	118 349 382 384	135	Sony	000 001 002 003 004 005 006 049 052 055 056 057 060 061 065 076 081 092 094 097 109 112 114 126 127 128 146 147 148 155 230 231 232 316 317 318 335
54	Goldstar	120	136	Sungale	267
55	GPX	194	137	Superscan	124 324
56	Gradiente	270 325	138	SVA	364
57	Greenhill	343	139	Sylvania	042 063 124 133 159 204 225 285 324 354 385 386
58	Grundig	339	140	Symphonic	133 159 385
59	Haier	334	141	Teac	266 328 371 379 380
60	Harman/Kardon	224 347	142	Technics	325
61	Hitachi	014 136 203 244	143	Techwood	261
62	Hitekter	342	144	Terapin	366
63	iLive	293	145	Theta Digital	340
64	Ilo	213	146	Toshiba	007 008 009 010 011 050 053 084 088 089 096 107 130 131 140 163 169 170 171 175 186 212 215 216 217 221 238 239 240 254 255 323 336
65	iLuv	314	147	Tredex	362
66	Initial	278 343	148	Trutech	296
67	Insignia	274 289 298 303 354	149	Tview	313
68	Integra	326 340	150	Urban Concepts	336
69	Irradio	174	151	US Logic	213
70	iSymphony	294	152	Venturer	288 328
71	Jamo	308	153	Vizio	367 369
72	JBL	162 347	154	Vocopro	315
73	Jensen	311 331	155	Westinghouse	222
74	JVC	030 031 032 033 034 035 036 037 038 086 087 095 103 122 141 142 161 173 214 218 243 306 341	156	Xbox	338
75	Jwin	309	157	Yamaha	180 253 325 339
76	Kawasaki	328	158	Zenith	102 116 120 139 149 336 345 349
77	Kenwood	325			
78	KLH	115 272 328 343			
79	Konka	359 360			
80	Koss	153 286 327 334			
81	Landel	363			
82	Lasonic	263 348			

# Universal Remote Control

## Remote Control Codes

### VCR

NO.	Brand	Code
1	ABS	111
2	Adventura	008 032
3	Aiwa	008 032 095 112
4	Akai	019
5	Alienware	111
6	American High	031
7	Apex	115
8	Asha	012 029
9	Audio Dynamics	016
10	Audiovox	030 082 112
11	Bang & Olufsen	113
12	Beaumarck	012 029
13	Bell & Howell	028
14	Broksonic	074 099 114
15	Calix	030 112
16	Candle	029 030
17	Canon	031
18	CineVision	094
19	Citizen	029 030 112 121
20	Colortyme	016
21	Colt	118
22	Craig	012 029 030 112
23	Curtis Mathes	016 029 031
24	Cybernex	012 029
25	Cyberpower	111
26	Daewoo	018 032 051 093 121
27	Davidson	008
28	DBX	016
29	Dell	111
30	Denon	013
31	Diamond/Vision	107
32	DIRECTV	110 122 124 125 129 130 134 136
33	Dishpro	133
34	Durabrand	025
35	Dynatech	008 032
36	Echostar	133
37	Electrohome	010 030 112
38	Electroponic	030 112
39	Emerson	008 010 020 030 031 032 105 112 116 121
40	ESA	101
41	Expressvu	133
42	Fisher	028 073
43	Fuji	031
44	Funai	008 020 032 105 116
45	Garrard	008 032
46	Gateway	111
47	GE	012 029 031 055 119
48	Go Video	012 072
49	GOI	133
50	Goldstar	016 030 106 112 120
51	Gradiente	008 032
52	Harley Davidson	032
53	Harman/Kardon	016
54	Headquarter	028
55	Hewlett Packard	111
56	Hitachi	008 013 048
57	HNS	110
58	Howard Computers	111
59	HP	111
60	HTS	133
61	Hughes Network Systems	013 110 122 124 125 130
62	Humax	110 122
63	Hush	111
64	iBUYPOWER	111
65	Insignia	081
66	Instant Replay	031
67	JC Penney	016 028 029 030 031
68	JCL	031
69	JVC	014 015 016 028 040 059 060 083 084 085 086 122 133
70	KEC	112
71	Kenwood	016 028
72	Kodak	030 031 112
73	LG	030 081 091
74	Linksys	111
75	Lloyd's	008 032
76	LXI	030 112
77	Magnasonic	020 121
78	Magnavox	008 020 021 025 027 031 044
79	Magnin	012 030 119
80	Marantz	016 028 031
81	Marta	030 112
82	Matsushita	031
83	Media Center PC	111
84	MEI	031

NO.	Brand	Code
85	Memorex	008 012 025 028 029 030 031 032 100 108 112 114 117 120
86	MGA	010 012 119
87	MGN Technology	012 029
88	Microsoft	111
89	Mind	111
90	Minolta	013
91	Mitsubishi	010 041
92	Motorola	031
93	MTC	008 012 029
94	Multitech	008 029 032
95	NEC	016 028
96	Nikko	030 112
97	Niveus Media	111
98	Noblex	012 029
99	Northgate	111
100	Olympus	031
101	Optimus	020 030 112 117
102	Optonica	023
103	Orion	045 108
104	Panasonic	000 001 002 003 031 035 037 056 063 079 089 098 109 117 128
105	Penney	012 013 112 119 120
106	Pentax	013
107	Philco	031
108	Philips	023 031 044 071 087 110 116 122 124 125 126
109	Philips Magnavox	044
110	Pilot	030 112
111	Polaroid	104 115
112	Presidian	116
113	Profitronic	012
114	Proscan	069 070 134
115	Pulsar	025
116	Pye	103
117	Quarter	028
118	Quartz	028
119	Quasar	031 076 117
120	Radio Shack	008 023 030
121	Radio Shack/Realistic	023 028 029 030 031 032
122	Radix	030 112
123	Randex	030 112
124	RCA	011 012 013 029 031 034 058 067 097 110 119 122 124 134 136
125	Realistic	008 023 028 029 030 031 032 112
126	ReplayTV	109 127
127	Ricavision	111
128	Runco	025
129	Samsung	012 017 018 019 029 043 049 050 068 080 110 124
130	Sanky	025
131	Sansui	008 045 102 108 114
132	Sanyo	012 028 029 073 119
133	Scott	010 018
134	Sears	008 013 028 030 031 112 120
135	Sharp	022 023 052 090 096
136	Shogun	012 029
137	Singer	031
138	Sonic Blue	109 127
139	Sony	004 005 006 007 008 033 036 038 039 046 064 065 066 075 111 123 131 135
140	Stack	111
141	STS	013 031
142	Superscan	021
143	Sylvania	008 010 020 021 031 032 048 062 088 116
144	Symphonic	008 020 021 032 105 116
145	Systemax	111
146	Tagar Systems	111
147	Tandy	028
148	Tashiko	030
149	Teac	008 032
150	Technics	031
151	Teknika	008 030 031 032 112
152	Thomas	008
153	Tivo	110 122 123 124 126 130 131 135
154	TMK	012 029
155	Toshiba	009 010 018 042 047 053 054 057 061 077 111 132
156	Totevision	012 029 030 112
157	Touch	111
158	UltimateTV	136
159	Unitech	012 029
160	Vector	018
161	Vector Research	016
162	Video Concepts	016 018
163	Videomagic	112
164	Videosonic	012 029
165	Viewsonic	111
166	Villain	008
167	Voodoo	111
168	Wards	008 012 013 023 029 030 031 032
169	White Westinghouse	105
170	XR-1000	008 031 032
171	Yamaha	016 028
172	Zenith	008 024 025 026 078 092
173	ZT Group	111

# Universal Remote Control

## Remote Control Codes

### SETBOX

NO.	Brand	Code
1	AccessHD	076
2	Alpha Digital	076
3	Alphastar	036
4	Artec	072
5	CaptiveWorks	067
6	Channel Master	078
7	Chaparral	027
8	Coolsat	066
9	Coship	083
10	Crossdigital	099
11	Digital Stream	077
12	DIRECTV	006 007 008 009 010 011 012 017 022 023 024 025 026 040 043 047 048 049 050 052 053 055 057 085 086 088 091 096 097
13	Dish Network	000 001 002 003 013 014 087 089 092 095
14	Dishpro	087 089 092 095
15	Drake	028
16	Echostar	000 013 014 087 089 092 095 098
17	Expressvu	089 095 098
18	GE	004 005 080
19	General Instrument	029 093
20	GOI	095
21	Goodmind	081
22	Hisense	094
23	Hitachi	023 037
24	HTS	095
25	Hughes Network Systems	008 011 016 017 019 024 040 052 085
26	Humax	068
27	Ilo	094
28	Insignia	075
29	Jerrold	093
30	JVC	000 013 014 095
31	Lasonic	082
32	LG	059 071
33	Magnavox	022 073
34	Memorex	022
35	MicroGem	074
36	Mitsubishi	017 063
37	Motorola	090 093
38	Next Level	093
39	Panasonic	009 057 060 061
40	Pansat	064
41	Paysat	022
42	PCT	078
43	Philco	073
44	Philips	008 016 017 019 021 022 049 050 085
45	Pioneer	008
46	Primestar	035
47	Proscan	004 005 051 088
48	Proton	094
49	Radio Shack	093
50	RCA	004 005 006 019 025 039 041 044 045 046 047 048 051 069
51	Realistic	030
52	Samsung	008010 018 019 020 053 056 058
53	Sharp	062
54	Sony	007 015 042 043 054 055 086
55	Star Choice	090 093
56	STS	038
57	STS1	031
58	STS2	032
59	STS3	033
60	STS4	034
61	Tivax	0776
62	Tivo	008 019
63	Toshiba	011
64	UltimateTV	086
65	Uniden	022
66	US Digital	094
67	Viewsat	065
68	Voom	093
69	Zenith	012 070 079
70	Zentech	084

### CABLE

NO.	Brand	Code
1	ABC	009 010 011 013 031 044
2	Adelphia	007
3	Americast	050
4	Antronix	015 016

NO.	Brand	Code
5	Archer	016
6	AT&T	003
7	Bell South	050
8	Cable Vision	006
9	Cabletenna	015
10	Cableview	014
11	Clearmaster	049
12	ClearMax	049
13	Colour Voice	018
14	Comcast	000 005
15	Comtronics	019
16	Contec	020
17	Coolmax	049
18	COX	005
19	Daeryung	057
20	Director	043
21	Dumont	056
22	Eastern	021
23	Everquest	045
24	Focus	048
25	GC Electronics	016
26	GE	009 010
27	Gehua	055
28	Gemini	045
29	General Instrument	005 008 010 040 042 043
30	Goldstar	046
31	Hamlin	022
32	Hitachi	010
33	Jasco	045
34	Jerrold	008 010 031 032 040 042 043 045
35	LG	053
36	Magnavox	025
37	MegaCable	005
38	Memorex	024 044
39	Motorola	000 003 005 008 039 040 042 043
40	Movie Time	025
41	Multitech	049
42	NEC	012
43	NET Brazil	036
44	NSC	025
45	Oak	020
46	Pace	001 047
47	Panasonic	028 030 044
48	Paragon	044
49	Philips	017 018 023
50	Pioneer	002 026 033 038 046
51	Popular Mechanics	048
52	Proscan	009 010
53	Pulsar	044
54	Quasar	044
55	Radio Shack	045 049
56	RCA	014 030
57	Realistic	016
58	Recoton	048
59	Regal	020
60	Regency	021
61	Rembrandt	010
62	Runco	044
63	Samsung	001 026 035 046
64	Scientific Atlanta	001 002 003 007 013 037 038 041
65	Signal	045
66	Signature	010
67	Sony	006 051
68	Sprucer	030
69	Standard Component	027
70	Starcom	031 045
71	Stargate	045
72	Starquest	045
73	Supercable	040
74	Supermax	049
75	TIME WARNER	004
76	Tocom	011
77	Torx	052
78	Toshiba	044
79	Trans PX	054
80	Tristar	049
81	TS	052
82	Tusa	045
83	Tv86	025
84	Unika	015 016
85	United Cable	031
86	Universal	015 016
87	V2	049
88	View Star	020 023 025
89	Viewmaster	049
90	Vision	049
91	Vortex View	049
92	Zenith	029 034 044 050
93	Zentek	048

# Universal Remote Control

## Remote Control Codes

### AUDIO

NO.	Brand	Code
1	Accuphase	292
2	Acurus	266
3	ADC	319
4	Adcom	208 219
5	Admiral	308
6	ADS	309
7	Aiwa	118 126 168 318
8	Akai	310
9	Alco	332
10	Altec Lansing	301
11	Amphion Media Works	325
12	AMW	325
13	Anam	321
14	Angstrom	267
15	Apex	195
16	Arcam	294 311
17	AudioSource	268
18	Audiotronic	322
19	Audiovox	190 214 220 332
20	B & K	213 236
21	Bang & Olufsen	336
22	Bel Canto Design	269
23	Biamp	270
24	BOSE	071 088 285
25	Boston Acoustics	305
26	California Audio Labs	271
27	CambridgeSoundWorks	241
28	Capetronic	319
29	Carver	318 322
30	Cary Audio Design	272
31	Casio	329
32	Chase Technologies	273
33	Clarinette	329
34	Classe	297
35	Classic	221
36	Coby	147 331
37	Creative	274 302
38	Curtis	207
39	Curtis Mathes	283
40	Dell	312
41	Denon	053 054 055 056 057 133 134 156 157 158 160 161 163 164 165 171 172 176 180 185 187 188 189 206
42	Digital Audio Control	275
43	Dual	258
44	Durabrand	299
45	Eclipse	218
46	Elan	295
47	Emerson	229
48	Fisher	326
49	Fonmix	303
50	Fosgate	276
51	GE	048 282
52	Glory Horse	331
53	Go Video	306
54	GPX	196
55	Gradiente	235 313
56	Harman/Kardon	177 224 286 318
57	Hitachi	326
58	iLive	244
59	Inkel	314
60	Insignia	233 240
61	Integra	317
62	iSymphony	245
63	Jamo	256
64	JBL	186 193
65	Jensen	257
66	JVC	032 033 034 035 036 037 104 121 150 182 211 284 331
67	Kenwood	038 039 040 041 042 073 082 089 095 115 122 130 135 323
68	KLH	332
69	Knoll Systems	277
70	Koss	237 324
71	Krell	225
72	Left Coast	386
73	Lenox	299 333
74	LG	175
75	Linn	318
76	Lloyd's	329
77	Logitech	278
78	Luxman	279 288

NO.	Brand	Code
79	Magnavox	075 191 318 319 322 329
80	Marantz	215 228 260 286 291 318 322 328
81	Mark Levinson	298
82	McIntosh	227
83	MCS	328
84	Memorex	315
85	Midiland	280
86	Mitsubishi	184 194
87	Modulaire	329
88	NAD	261 335
89	Nakamichi	291 334
90	NEC	290
91	Nikko	281
92	Onkyo	043 044 045 046 047 080 018 087 094 097 119 124 127 146 166 167 178 181 203 217
93	Optimus	283 293 319 320 321 330
94	Oritron	324
95	Panasonic	019 020 201 022 023 024 069 076 077 091 098 107 113 144 151 209 328
96	Parasound	230
97	Penney	329
98	Philco	332
99	Philips	183 210 286 294 318 322
100	Pioneer	025 026 027 028 029 030 031 062 068 072 090 100 101 105 123 132 148 149 162 212 246 247 248 249 250 251 252 253 254 283 287 319 320
101	Polaroid	222 226
102	Polk Audio	216 286 318
103	Prima	307
104	Proscan	048
105	Qisheng	304
106	Quasar	328
107	RadioShack	331
108	RCA	048 049 050 051 151 137 234 283 319 320 321 332
109	Realistic	293 329
110	Regent	333
111	Rio	327
112	Rotel	231
113	Samsung	084 103 138 143
114	Sansui	291 318
115	Sanyo	238 326
116	Sharp	205 242 296
117	Sharper Image	331
118	Sherwood	145 243
119	Shure	290
120	Sonic Blue	327
121	Sony	000 001 002 003 004 005 006 007 058 058 059 060 061 063 064 065 066 067 070 074 079 085 093 108 109 110 111 112 117 125 128 129 131 140 170 262 263 264 265
122	Soundesign	282 289 330
123	Soundmatters	232
124	Soundstream	316
125	Stereophonics	320
126	Sunfire	323
127	Teac	223 321 332
128	Technics	052 086 114 116 141 328
129	Thorens	322
130	Toshiba	152
131	Tview	259
132	Venturer	239 332
133	Victor	284
134	Wards	282 287 289 318
135	Xantech	300
136	Yamaha	008 009 010 011 012 013 014 015 016 017 018 078 083 092 096 099 102 106 120 139 142 153 154 155 169 173 174 179 192 197 198 199 200 201 202 204 255 317
137	Yorx	329
138	Zenith	136 159

## Maintenance

Early malfunctions can be prevented. Careful and regular cleaning can extend the amount of time you will have your new TV. Be sure to turn the power off and unplug the power cord before you begin any cleaning.

### Cleaning the Screen

1. Here's a great way to keep the dust off your screen for a while. Wet a soft cloth in a mixture of lukewarm water and a little fabric softener or dish washing detergent. Wring the cloth until it's almost dry, and then use it to wipe the screen.
2. Make sure the excess water is off the screen, and then let it air-dry before you turn on your TV.

### Cleaning the Cabinet

To remove dirt or dust, wipe the cabinet with a soft, dry, lint-free cloth. Please be sure not to use a wet cloth.

### Extended Absence

If you expect to leave your TV dormant for a long time (such as a vacation), it's a good idea to unplug the power cord to protect against possible damage from lightning or power surges.



## Product Specification

<b>Resolution</b>	1366X768(Dot)
<b>Power requirement</b>	120V~ , 60Hz
<b>Stand-by Consumption</b>	less than 1W
<b>Color system</b>	NTSC, ATSC, Clear QAM
<b>External Antenna Impedance</b>	75 ohm
<b>Color</b>	16,770,000(256 steps of each R, G and B)
<b>Operating Temperature Range</b>	32~104°F(0~40°C)
<b>Operating Humidity Range</b>	Less than 80%
<b>Maximum Elevation</b>	6561 feet (2000m)

<b>Dimensen(WXDXH) Unit:inches/mm (Including stand)</b>	<b>Weight(pounds/kg)</b>
31.3X9.2 X22.9inches 796X233X582 mm	27.6/12.5

■ The specifications shown above may be changed without prior notice for quality improvement.

# Troubleshooting

For the sake of time and cost, it is strongly recommended that you check out the problem by yourself according to the instructions listed hereunder before contacting the after-sales service for technical assistance.

No picture, no sound	Verify if the television is properly plugged. Verify if the television is properly supplied power. Verify if electricity is available.
Blank screen	Verify if correct signals are input. Press INPUT button to change signal input to TV input. Restart the television if power supply is interrupted.
No sound	Press Mute button and verify if Mute mode is set. Switch to other channel and verify if the same problem happens. Press VOL+ button to see if the problem can be solved.
Poor sound	Verify if sound system is correct. Refer to Page 22 for adjustments.
No picture in some channel	Verify if correct channel is selected. Adjust the antenna. Make adjustments by Fine Tune and Manual Scan.
No color for some channel program (black and white)	Verify if the same problem exists in other channels. Check out of picture and sound systems. Refer to relative instructions in the Manual for color adjust.
Spots with some or all pictures	Verify if the antenna is correctly connected. Verify if the antenna is in good condition. Make fine adjustment of channel.
Horizontal/vertical bars or picture shaking	Check for local interference such as an electrical appliance or power tool.
Television out of control	Disconnect the television from power supply and, 10 seconds later, connect the television to the power supply. If the problem still exists, contact authorized after-sales service for technical assistance.

**Note:** Do not leave the television with static picture in an extended period as the image may become permanently burned.

**Note:** Production of the LCD screen requires high and precision technologies. However, there might be some dark or bright (red, blue or green) spots, or some anomalistic stripes or spots. This is not defect. If the TV set is used in an area 2,400 meters above the sea level where the air pressure is below 750hpa, the picture on the LCD screen may be affected and a muffled sound might be produced. These phenomena might happen in the area 1,500 meters above the sea level. This is resulted from difference between air pressures inside and outside the display. This is not a defect covered by the limited warranty.

## Warranty



### LIMITED WARRANTY - LCD

**PWV Service Inc.** warrants to you, the original purchaser of this Product, that this product shall be free of defects in material or workmanship for a period of one year (365 days) from the date of purchase as follows:

1. **LABOR:** During the Warranty Period if this Product is determined to be defective, **PWV Service Inc.** will repair or replace the Product, at its option at no charge, or pay the labor charges to any authorized service facility. After the Warranty Period, you must pay for all labor charges.
2. **PARTS:** In addition, **PWV Service Inc.** will supply, at no charge, new or rebuilt replacement parts in exchange for defective parts for the Warranty Period. The LCD Panel contains pixels which are picture elements that make up the image seen on the TV display; **PWV Service Inc.** warrants the LCD panel will contain no more "dead or stuck" pixels than what is specified by the LCD module maker for the warranty period. After the Warranty Period, you must pay all parts costs. To determine what the dead/bright pixel specification for the panel maker in this product, please contact our service center for more information.

To obtain warranty service, you must take the Product with your **original receipt or other proof of purchase**, either in its original packaging or packaging affording an equal degree of protection, to your original place of purchase, or the location specified by **PWV Service Inc.** from which you purchased the Product.

This warranty does not cover customer instruction, installation, non-service related adjustments, removing / installing the TV from/to a mounting bracket and/or wall and resolving signal reception problems. Please note that this product's screen is made using high-precision technology. However, the screen may display multiple black or bright points of light (red, blue or green) constantly on the screen. Irregular colored stripes or varying brightness may also appear on the screen, and this is not a defect in material or workmanship that is covered by this warranty.

This warranty does not cover cosmetic damage or damage due to acts of God, lightning strikes, accident, misuse, abuse, negligence, commercial use, or modification of, or to any part of the Product, including the antenna. This warranty does not cover damage due to improper operation or maintenance, connection to improper voltage supply, or attempted repair by anyone other than a facility authorized by **PWV Service Inc.** to service the Product. This warranty does not cover Products sold **AS IS** or **AS REFURBISHED**, or consumables (such as fuses or batteries). This warranty is valid only in Canada.

This warranty is invalid if the factory applied serial number has been altered or removed from the Product.

REPAIR REPLACEMENT AS PROVIDED UNDER THIS WARRANTY IS THE EXCLUSIVE REMEDY OF THE CONSUMER. **PWV Service Inc.** SHALL NOT BE LIABLE FOR ANY INCIDENTAL OR CONSEQUENTIAL DAMAGES FOR BREACH OF ANY EXPRESS OR IMPLIED WARRANTY ON THIS PRODUCT. EXCEPT TO THE EXTENT PROHIBITED BY APPLICABLE LAW, ANY IMPLIED WARRANTY, REPRESENTATION OR CONDITION OF MERCHANTABILITY OR FITNESS FOR A PARTICULAR PURPOSE ON THIS PRODUCT IS LIMITED IN DURATION TO THE DURATION OF THIS WARRANTY.

Some provinces do not allow the exclusion or limitation of incidental or consequential damages, or allow limitations on how long an implied warranty lasts, so the above limitations or exclusions may not apply to you. This warranty gives you specific legal rights, and you may have other rights which vary from province to province.

For customer service please call **1-866-447-7462** 

[www.pwvice.com](http://www.pwvice.com) 

PWV Service Inc. 13200 Delf Place, Unit 180, Richmond, BC. V6V 2A2, Canada



